

# Moisture conditions of outdoor air-ventilated crawl spaces in apartment buildings in a cold climate

Jarek Kurnitski\*, Miimu Matilainen

*Helsinki University of Technology, HVAC-Laboratory, P.O. Box 4400, FIN-02015 Hut, Finland*

Received 12 May 1999; accepted 19 April 2000

## Abstract

The effects of air change and ground covers on crawl space moisture balance in a cold climate are discussed in this paper. The objectives were to assess the suitability of outdoor air-ventilation in the crawl spaces of apartment buildings, to determine the optimum air change rate with and without ground covers, and the effect of the ground covers' thermal insulation on moisture behaviour. Measured data from the test building was used to develop the crawl space model in a modular simulation environment, where the parametric simulations were carried out. The air change rate was varied between 0–10 ach to study moisture behaviour with covered and uncovered ground surface. Moisture evaporation was included in the moisture balance, but moisture storage in the constructions and in the ground was not. The results show that evaporation and thermal behaviour are the key elements determining the resulting relative humidity in crawl spaces. If moisture evaporation is entirely prevented, the crawl space may be left unventilated. In other cases, ventilation is always required to remove the moisture. The higher air change rates increased moisture evaporation from uncovered ground, but still brought about lower relative humidity. The rise from 0.5 to 3 ach increased evaporation from 2.4 to 4.9 g/m<sup>2</sup> h and decreased the highest monthly average of relative humidity from 81 to 74%. For the uncovered ground the lowest relative humidity was achieved at 2–3 ach air change in winter, but in the summer, the higher the air change the lower the relative humidity. Ground covers made it possible to decrease relative humidity and to increase temperature significantly due to reduced moisture evaporation. Ground cover with thermal insulation was in principle more effective than without insulation as it provided a slightly higher temperature rise in summer. The studied 5 cm expanded polystyrene layer reduced moisture evaporation to 0.3–0.4 g/m<sup>2</sup> h, increased crawl space temperature by 2–3°C and decreased relative humidity below the 60% level when air change was 0.5–1 ach. In general, outdoor air-ventilation demonstrated very high performance in the crawl space of the studied apartment building when a ground cover was applied. © 2000 Elsevier Science S.A. All rights reserved.

*Keywords:* Crawl space; Dynamic simulation; Moisture evaporation; Optimum air change; Ground covers

## 1. Introduction

It is known that the behaviour of crawl spaces becomes problematic in the summer when outdoor air is often warmer and with higher moisture content than the crawl space air. This means that outdoor air can transport moisture into the relatively cold crawl space and as a result the relative humidity (RH) will rise. Samuelson [1] reports 85–95% RH during summer, and even 100% under extreme conditions over a period of several weeks. To avoid high RH some innovative solutions are being worked out. For example, an unventilated crawl space application needs perfect moisture insulation [2] — if there is no moisture source there is no need for ventilation. In the crawl space heated by exhaust air

[3], the heat insulation level should also be relatively high to avoid condensation during the heating season. As such applications are quite expensive and have high requirements for workout, an outdoor air-ventilated crawl space still seems to be the most commonly used one in practice.

In crawl spaces, it is usually considered that a RH over 80–85% [1,7,8] during a period of several weeks or months might cause mould growth. (Temperature is high enough for mould growth because it is usually over +5°C in crawl spaces.) RH in crawl spaces is the result of ground moisture evaporation, air change rate and thermal behaviour being all strongly linked. The air change affects conditions in opposite ways. In the heating season, the crawl space is warmer than outdoor air, and outdoor air with its low moisture content effectively removes the moisture from the crawl space. At the same time, air change decreases the temperature and excessive air change will increase RH. In summer, outdoor air is periodically warmer than crawl space air thus

\* Corresponding author. Tel.: +358-9-451-3609; fax: +358-9-451-3418.  
E-mail address: jarek@cc.hut.fi (J. Kurnitski)

the ventilation works inefficiently. Outdoor air with a high moisture content will even transport some net moisture into the crawl space in the summer. At the same time, ventilation warms up the crawl space and this decreases the RH.

In the Finnish apartment buildings discussed in this study, outdoor air-ventilated crawl spaces are relatively warm due to the rather high  $U$ -value of base floors (about  $0.35 \text{ W/m}^2 \text{ K}$ ). The field measurements carried out in [4,5] showed that there are good chances to avoid high RH. To achieve that, proper air change rates and ground covers must to be used. The effect of air change on RH is a particularly pressing question, since a highly typical repair job in such apartment buildings is to increase the air change rate by adding ventilation pipes, openings, or by extract fan, and to clean crawl space of organic materials and other rubbish. An uncovered ground surface is quite often maintained in crawl spaces, as it is believed that ventilation is the key issue. In this study, the parametric simulation of air change effect on RH with and without ground cover will be carried out. The question of optimum ventilation rate and moisture reduction in crawl space has been the actual issue over the last decades. Rose concludes in [6] that there is general agreement in the previous literature that ground covers are effective in reducing humidity, but there is no convincing technical basis for current building code requirements for ventilation.

If the effects of air change and ground covers are studied by field measurements then long-term measurement periods are needed. This is made necessary by the high heat capacity of the ground (and foundations) leading to continuously unsteady conditions in crawl spaces. In the present study, the results from field measurements are used for the identification of required parameters and for the validation of the model. The simulation makes it possible to study a much

higher number of cases than can be studied by field measurements.

## 2. The model

The RC-network model was developed in IDA simulation environment [9,10] for the crawl space of the test building. IDA is a modular simulation environment consisting of translator, solver and modeller. In a modular simulation environment, modules and solver are separated and modules are handled as data, i.e. for the same component completely different mathematical formulations may be used without any changes in a model description file. A module system may be hierarchical; modules will be linked and boundary conditions given in the model description file. Several module libraries concerning building and HVAC-components are available for the building simulation. Modules are written in Neutral Model Format (NMF), which serves at the same time as a readable document and computer code. Every module consists of equations, links and variable and parameter definitions.

The modelled test building represents a typical Finnish apartment building where there is no alternative to a crawl space foundation because the building foundation rests on piles in clay ground soil. A section of modelled crawl space is shown in Fig. 1a. There is 10 cm expanded polystyrene insulation (EPS) in the floor and 5 cm insulation layers in the foundations and the ground. The rest of the materials are concrete and clay. To describe the insulation in foundations (where is two layers of EPS, Fig. 1) the insulation layer with a resulting thickness of 7 cm was used. A plan of the crawl space and the division of the floor area into two sectors are

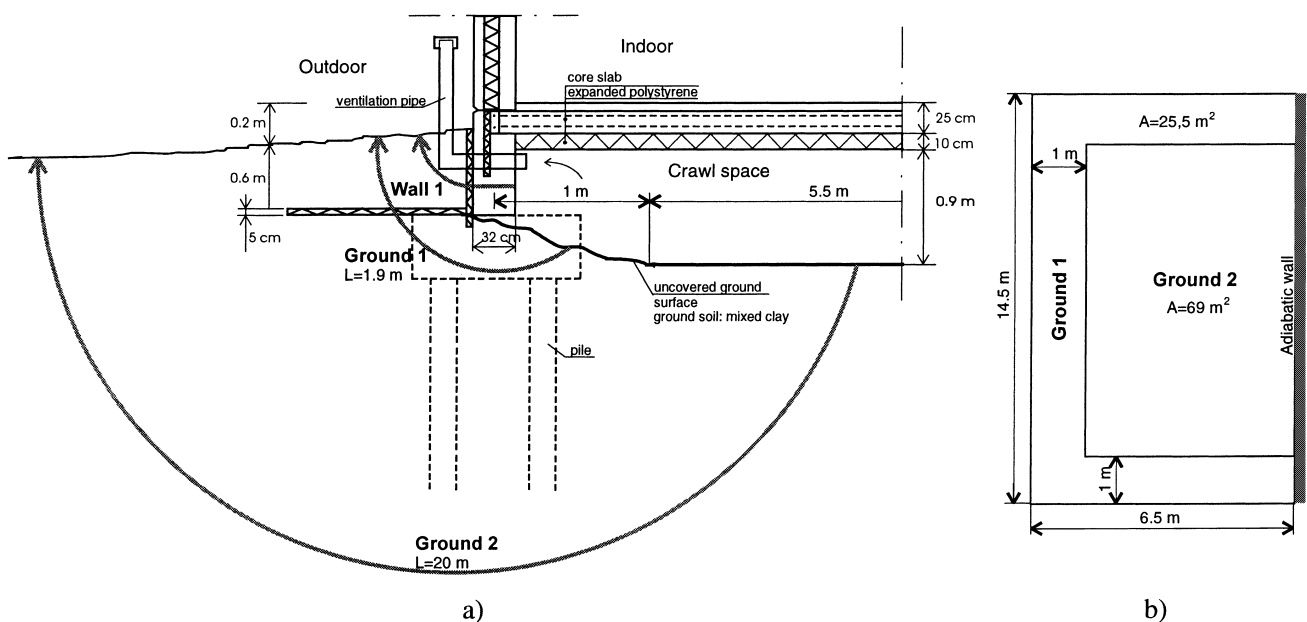

Fig. 1. Section (a) and plan (b) of the modelled crawl space.

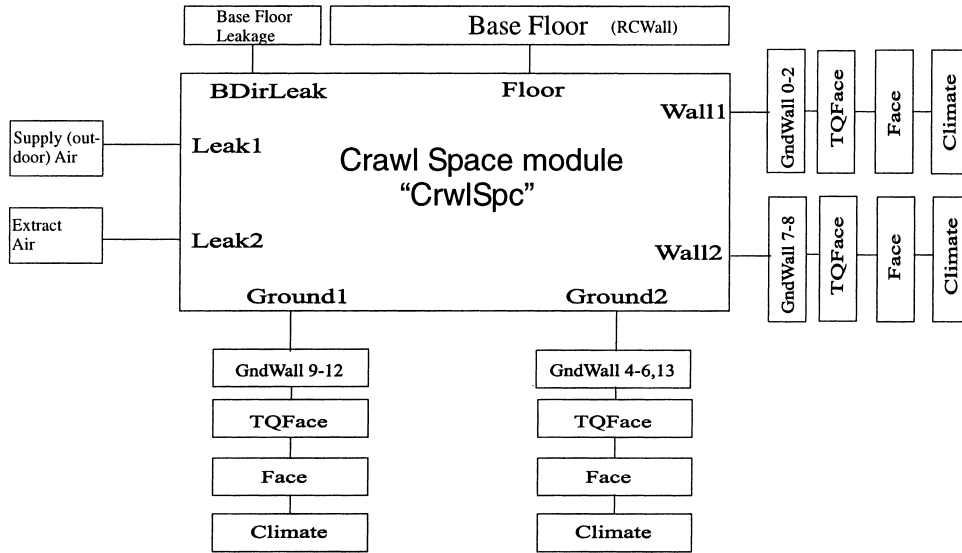

Fig. 2. The module system of the crawl space model showing the components used and the flow patterns in the model.

shown in Fig. 1b. The adiabatic wall represents the foundation beam, bearing the hollow-core slabs and dividing the crawl space of the current block into two parts. Thus, the width of the modelled crawl space is 13 m. The heat conduction in the ground soil is modelled with the semicircular heat flow patterns, ‘Ground 1’, ‘Ground 2’ and ‘Wall 1’ as shown in Fig. 1a. The heat flow along circular arcs that is known from heat conduction theory (reported for example in heat loss calculation methods by Vuorelainen [11] and Hagentoft [12]) is applied here for a dynamic simulation of heat transfer. The floor area is divided into two parts: into the first meter along the external walls and the remainder. Thus, the ground surface is subjected to two temperatures, and the external walls and base floor to one single temperature. When the model was being worked out, three heat flow patterns in the ground were tested, but this provided almost the same results as the traditional division into two flow patterns. The modelling of the inner floor area as a 10 m thick layer of soil having a constant annual average tem-

perature at its bottom was tested as well. The results were the same as with semicircular ‘Ground 2’.

In the simulation environment, heat and moisture balance equations are expressed in the form of one module named ‘CrwlSpc’. The whole module system for solving the crawl space problem is shown in Fig. 2. Here, the modules representing the base floor, walls, ground and air change are linked with a crawl space module. For heat transfer in ground soil a simple module ‘GndWall’ was worked out and the remainder were standard modules of the simulation environment.

Modelled heat, air and moisture flows are shown in Fig. 3. To achieve a dynamic simulation, the energy balance for the crawl space air and the heat balance for the base floor, walls and ground has to be stated. Humidity balance should be written similarly for the crawl space air. The moisture flows taken into account are evaporation from the ground surface and flows carried by ventilation. If evaporation is significant, i.e. when ground is uncovered the heat of evaporation  $Q_{eva}$

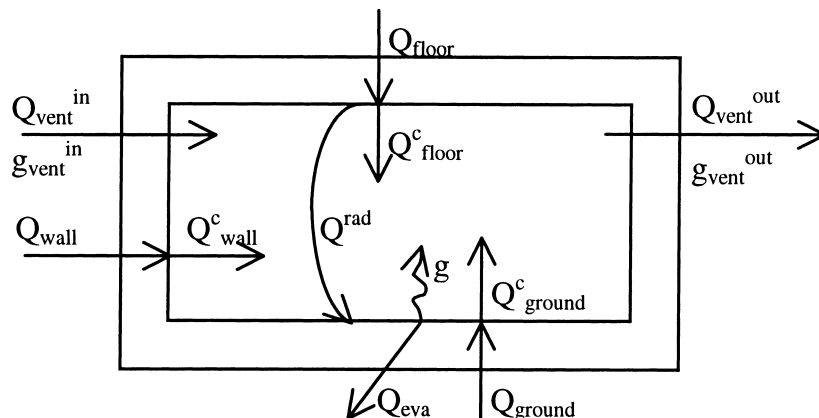

Fig. 3. Modelled heat ( $Q$ ) and moisture ( $g$ ) flows in crawl space. Superscript ‘c’ marks convection.

should be taken into account. The energy and moisture balance equations for crawl space air are

$$C \frac{\partial T_{\text{air}}}{\partial t} = Q_{\text{floor}}^c + Q_{\text{ground}}^c + Q_{\text{wall}}^c + Q_{\text{vent}}^{\text{in}} - Q_{\text{vent}}^{\text{out}} \quad (1)$$

$$V \frac{\partial v_{\text{air}}}{\partial t} = g_{\text{vent}}^{\text{in}} + g - g_{\text{vent}}^{\text{out}} \quad (2)$$

where  $C$  is the heat capacity of air (J/K),  $T_{\text{air}}$  the air temperature in crawl space (K),  $Q$  the heat flux (W),  $V$  the volume of crawl space ( $\text{m}^3$ ),  $g$  the moisture flow (kg/s) and  $v_{\text{air}}$  the humidity by volume of crawl space air ( $\text{kg}/\text{m}^3$ ). Heat balance equations for surfaces (radiation heat transfer is considered only between base floor and ground) are

$$\begin{aligned} Q_{\text{floor}} &= Q_{\text{floor}}^c + Q^{\text{rad}} \\ Q_{\text{wall}} &= Q_{\text{wall}}^c \\ Q_{\text{ground}} &= Q_{\text{ground}}^c - Q^{\text{rad}} + Q_{\text{eva}} \end{aligned} \quad (3)$$

Convective heat fluxes from base floor, walls and ground to crawl space, radiation heat flux between base floor and ground, and latent heat of evaporation are defined as follows:

$$\begin{aligned} Q_{\text{floor}}^c &= \alpha_{\text{floor}} A_{\text{floor}} (T_{\text{floor}} - T_{\text{air}}) \\ Q_{\text{wall}}^c &= \alpha_{\text{wall}} A_{\text{wall}} (T_{\text{wall}} - T_{\text{air}}) \\ Q_{\text{ground}}^c &= \alpha A_{\text{ground}} (T_{\text{ground}} - T_{\text{air}}) \\ Q^{\text{rad}} &= \frac{\sigma A_{\text{ground}}}{(1/\varepsilon_{\text{F}}) + (1/\varepsilon_{\text{G}}) - 1} (T_{\text{floor}}^4 - T_{\text{ground}}^4) \\ Q_{\text{eva}} &= gE \end{aligned} \quad (4)$$

where  $A$  is the area ( $\text{m}^2$ ),  $T$  the temperature (K),  $\alpha_{\text{floor}}$  a constant convective heat transfer coefficient for base floor ( $2.3 \text{ W}/\text{m}^2 \text{ K}$ ) and  $\alpha_{\text{wall}}$  for walls (foundations) ( $4.6 \text{ W}/\text{m}^2 \text{ K}$ ) (for ground  $\alpha$  is calculated),  $\sigma$  the Stefan–Boltzmann's constant ( $5.67 \times 10^{-8} \text{ W}/\text{m}^2 \text{ K}^4$ ),  $\varepsilon_{\text{F}}$  and  $\varepsilon_{\text{G}}$  are the emissivities of base floor and ground 0.9 and  $E$  the heat of evaporation ( $2.5 \times 10^6 \text{ J}/\text{kg}$ ). Since ground moisture evaporation and moisture flows carried by ventilation are the only moisture flows considered in crawl space, the moisture balance equation (Eq. (2)) can be stated

$$V \frac{\partial v_{\text{air}}}{\partial t} = x_{\text{out}} q_{\text{m}} + g - x_{\text{air}} q_{\text{m}} \quad (5)$$

where  $x_{\text{out}}$  is the absolute humidity in outdoor air ( $\text{kg}/\text{kg}$ ),  $q_{\text{m}}$  the air change in crawl space (kg/s),  $g$  the ground moisture evaporation (kg/s) and  $x_{\text{air}}$  the absolute humidity in crawls space air (kg/kg). It is assumed that there is complete mixing in the crawl space air. Ground moisture evaporation based on mass transfer coefficient and primary physical potential for diffusion is

$$g = \beta (p_{\text{ground}} - p_{\text{air}}) \frac{M_{\text{w}}}{RT} A_{\text{eva}} \quad (6)$$

where  $\beta$  is mass transfer coefficient (m/s),  $p_{\text{ground}}$  the vapour pressure on the ground surface (Pa) and  $p_{\text{air}}$  in crawl space air (Pa),  $M_{\text{w}}$  the molecular weight of water (0.018 kg/mol),  $R$  the universal gas constant (8.31 J/mol K),  $T$  the absolute temperature (K) and  $A_{\text{eva}}$  the area of the evaporation surface

( $\text{m}^2$ ). When one considers universal gas law that relates the vapour pressure and humidity by volume

$$p = v \frac{RT}{M_{\text{w}}} \quad (7)$$

the evaporation Eq. (6) can be expressed as follows:

$$g = \beta (v_{\text{ground}} - v_{\text{air}}) A_{\text{eva}} \quad (8)$$

where  $v_{\text{ground}}$  is the humidity by volume on the ground surface and  $v_{\text{air}}$  in the crawl space air ( $\text{kg}/\text{m}^3$ ). Humidity by volume  $v = x\rho$ , where  $\rho$  is density of air ( $\text{kg}/\text{m}^3$ ), is in the same way temperature dependent as vapour pressure (Eq. (7)). The evaporation Eq. (8) is valid when ground surface is wet, i.e. when moisture transport in the soil is larger or equal to the evaporation. If the ground surface is relatively dry, Eq. (8) gives an evaporation capacity that is larger than the moisture transport in the soil, i.e. overestimates the evaporation rate.

In the case of ground covers moisture transfer inside ground cover is taken into account by using Fick's law

$$g = \frac{(v_{\text{ground}} - v_{\text{air}})}{(d/\delta_{\text{v}}) + (1/\beta)} A \quad (9)$$

where  $v_{\text{ground}}$  is the humidity by volume below ground cover,  $d$  the thickness of ground cover (m),  $\delta_{\text{v}}$  the moisture permeability of ground cover ( $\text{m}^2/\text{s}$ ) and  $A$  the area of crawl space ( $\text{m}^2$ ). The RH below the ground cover can be usually assumed to be 100%; this was the situation in the test building with a plastic sheet cover [4]. The mass transfer coefficient  $\beta$  in Eq. (9) may be left out in most cases, because the value of  $d/\delta_{\text{v}} + 1/\beta$  is determined by moisture permeability of the ground cover. For example, with 5 cm expanded polystyrene the significance of  $1/\beta$  is less than 1%. To determine the mass transfer coefficient the convective heat transfer coefficient is used [13]

$$\beta = \frac{\alpha}{\rho c_p} \frac{\rho}{\rho_{\text{BM}}} \text{Le}^{1-n} \cong \frac{\alpha}{\rho c_p} \quad (10)$$

where  $\alpha$  is the convective heat transfer coefficient ( $\text{W}/\text{m}^2 \text{ K}$ ),  $\rho$  the density of air ( $\text{kg}/\text{m}^3$ ) and  $c_p$  the specific heat capacity of air ( $\text{J}/\text{kg K}$ ),  $\rho/\rho_{\text{BM}}$  is logarithmic density term and  $\text{Le}$  is Lewis number. For  $c_p$  it is taken  $1006 \text{ J}/\text{kg K}$  and density of air is calculated from gas law. The middle part of Eq. (10) is valid with the assumption of a laminar boundary layer, and theoretically it cannot be transformed into turbulent flow [13]. The right-hand side of Eq. (10) is the most common expression for mass transfer coefficient in engineering applications. The authors calculated the Lewis number and logarithmic density term within the temperature and humidity range present in crawl space and got for  $\text{Le}^{1-0.33}$  1.12 at  $20 \text{ }^\circ\text{C}$  and 1.14 at  $0 \text{ }^\circ\text{C}$ , and for  $\rho/\rho_{\text{BM}}$  about 1.01 within the complete range. Therefore, if the middle part of Eq. (10) is valid then the right part is valid with very high accuracy in temperature and RH range present in crawl space. How the assumption of laminar boundary layer works in crawl spaces can be seen from calculated results. The

convective heat transfer coefficient can be calculated with a natural convection equation

$$\alpha = 2.2\Delta T^{1/3} \quad (11)$$

This equation gave a sufficiently accurate result in the crawl space of the test building with average air change 1.4 ach [5]. In [5] the results of the field measurements (air change rate and  $T$  and RH in crawl space air, on ground surface and outdoors) were used to derive the evaporation rate from the moisture balance of the crawl space by using the steady state form of Eq. (5). From evaporation rate the values of  $\beta$  and  $\alpha$  were possible to calculate with Eqs. (8) and (10) and these were compared to the values calculated from temperature difference with Eq. (11). In the second crawl space section of the same test building, where applied air change was higher (about 3.3 ach), Eq. (11) slightly underestimated the heat transfer coefficient. The forced convection caused by air flows of ventilation pipes was found to be significant. The air velocity on the ground was roughly approximated and measured, and for high air change rates the following equation was recommended [5]

$$\alpha = 2.2\Delta T^{1/3} + 4v \quad (12)$$

where  $v$  is the velocity (m/s) stated as a linear function of air change:  $4v=5.4q_v$ , where  $q_v$  is airflow ( $\text{m}^3/\text{s}$ ).

### 3. Results

#### 3.1. Validation of thermal behaviour of the model

To find out the relevant number of calculation points for each material layer, the cases in which the total number of nodes was 21, 64 and 121 were compared. The 64-node model was selected for further calculations because there was not any significant difference compared to the 121-node model.

The parameter identification was carried out for thermal conductivity and capacity of the ground soil, and for the  $U$ -value of the base floor. This last was necessary due to a cold bridge in the joint of the base floor and the foundation beam (Fig. 1). The other material properties used were taken from the literature. The measured data taken at the beginning of measurement period over a 6-month period was used for the parameter identification. Monitored air change, outdoor temperature and RH were used as the boundary conditions for the model. The difference between measured and calculated crawl space air temperature was minimised.

The  $U$ -value of the base floor affected the temperature level in the crawl space clearly. To take the cold bridge into account the  $\lambda$  of expanded polystyrene was increased from 0.04 to 0.05 W/m K. The  $\lambda$  and  $c_p$  of the ground soil describe the thermal mass present in the crawl space, and they affected strongly the delay between outdoor and crawl space temperature and had only slight effect on temperature level. The parameters used in the calculations are shown in Table 1.

The  $U$ -value of base floor, calculated with  $\lambda$ -values shown in Table 1 is 0.38 W/m<sup>2</sup> K. The phase change of soil was not modelled because the crawl space temperature in winter was about 10°C and only a thin layer (0–20 cm) of the outside ground surface was frozen. District heating pipes in the crawl space were taken into account by including a 200 W heat source in the energy balance. For indoor air temperature 22°C was taken.

There was a significant leakage between the crawl space and apartments that can be seen from the air change measurements. The air change rate of naturally ventilated crawl space was measured from every ventilation pipe. This was based on the measurement of the pressure drop in ventilation pipes and is described in [4]. An example of air change measurement is shown in Fig. 4. A two-speed fan was used in the mechanical exhaust ventilation system of the building. The full speed increased under-pressure in apartments and the pressure difference compared to crawl space was increased as well. This change can be clearly seen from the supply air flow through ventilation pipes to crawl space. Zero value of extract flow through ventilation pipes indicates that almost all of the extract air of the crawl space flows through the base floor to apartments (there were only occasional peaks of extract flow through ventilation pipes in windy weather). Thus, it was not necessary to take the leakage into account since the flow direction was constantly from crawl space to apartments, and the measured supply air flow through ventilation pipes indicates the whole air change in the crawl space.

The calculated and measured crawl space air temperature is shown in Fig. 5. To obtain correct initial values, 1-year period (in some cases a 2–3-year period) was first calculated through, and the end values used as initial values for actual calculation. The calculated values are hourly values, but in Fig. 5 (and in the following figures) the moving average values with 24-h period are used to achieve an acceptable readability of results.

In calculated cases the inner area of crawl space (Ground 2) was modelled as a 20 m long circular arc as shown in

Table 1  
The material properties used in calculations

	Ground soil (mixed clay)	Concrete	Expanded polystyrene
Thermal conductivity (W/m K)	1.3	1.2	0.05
Specific heat capacity (J/kg K)	2000	1000	900
Density ( $\text{kg}/\text{m}^3$ )	1600	2400	20
Moisture permeability ( $\text{m}^2/\text{s}$ )			$0.8 \times 10^{-6}$

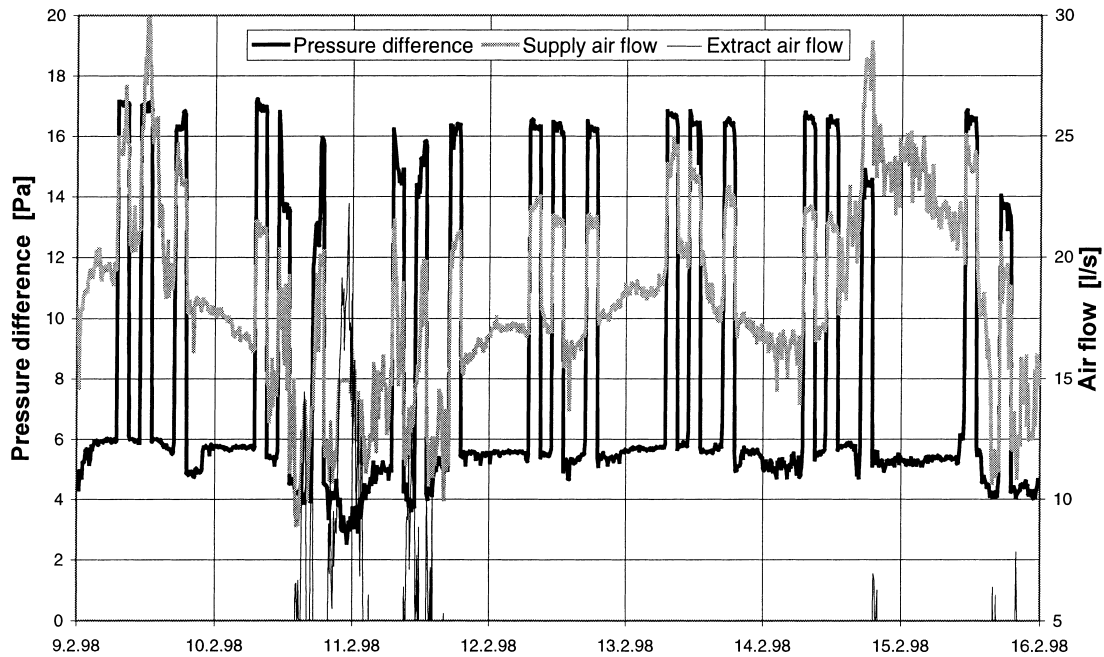

Fig. 4. Measured pressure difference between crawl space and apartments (under-pressure in apartments) and crawl space air flows through ventilation pipes (20 l/s corresponds 1 ach) during a typical week.

Fig. 1 or alternatively as a 10 m thick ground layer with  $6^{\circ}\text{C}$  annual average temperature at its bottom. In Fig. 5, the results of air temperature only with a circular arc are shown, but in Fig. 6 the ground surface temperatures calculated with both methods are shown. As there is no difference between these methods the further calculations were carried out with a circular heat flow pattern.

### 3.2. Validation of moisture behaviour of the model

Ground moisture evaporation from the uncovered ground surface was calculated as mass transfer from surface, since

moisture permeability of ground soil was unknown and Eq. (9) could not be applied. The convective heat transfer coefficient was calculated with Eq. (11) or (12). These equations were tested in [5] and it was known that they work in the crawl space with sufficient accuracy. From field measurements it was known that RH on the ground surface varies between 85 and 100%. Since there was a reasonably clear correlation between the RH and the evaporation rate (Fig. 7) up to  $4\text{ g/h m}^2$  evaporation rate, this correlation was used in calculations for RH on the ground surface. This means that moisture flow  $g$  is iterated from Eq. (8) and the correlation equation shown in Fig. 7. How-

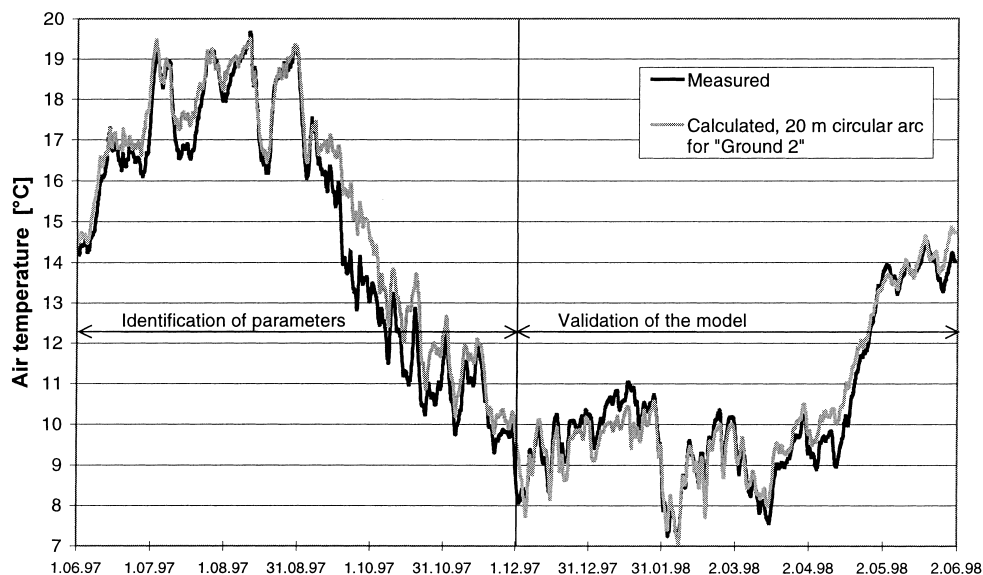

Fig. 5. Calculated and measured crawl space air temperature (24 h moving averages).

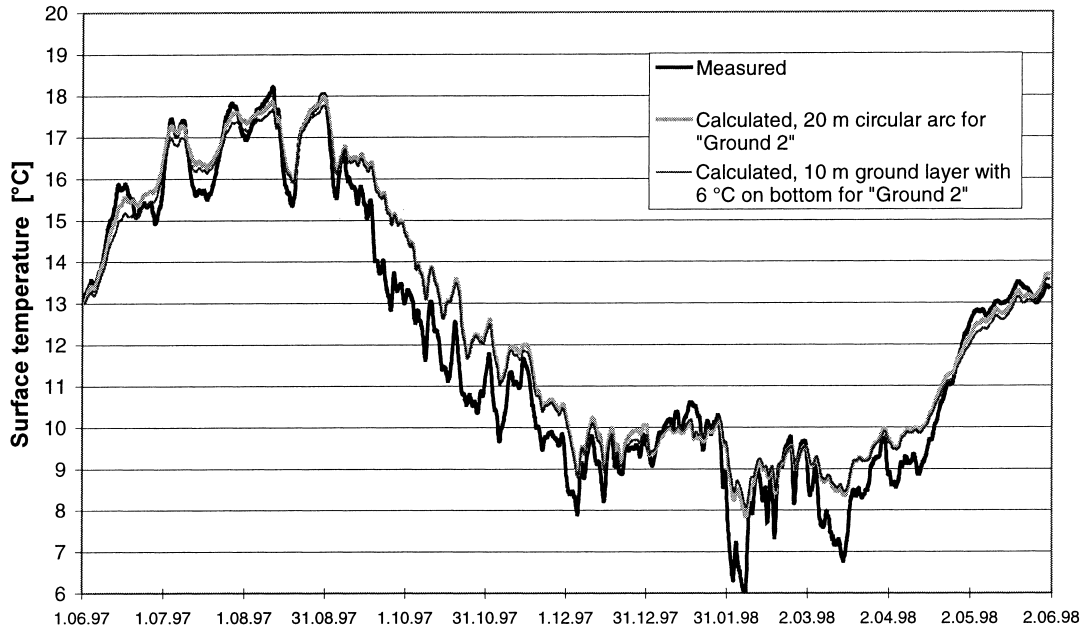

Fig. 6. Calculated and measured ground surface temperature in the crawl space. Calculated value is an average of temperatures of outer and inner sector, weighted by area (24 h moving averages).

ever, the correlation used is highly specific and is valid only for the ground soil and moisture conditions present in the test building.

Certain calculations were carried out with constant RH (90 or 100%) on the ground and in one case a constant heat transfer coefficient recommended in [14] was tested as well. In all calculated cases the parameter identification was

carried out for the reduction factor of the evaporation area. By this constant factor the inaccuracies in heat transfer coefficient equation, RH on the ground and the possible effect of moisture transfer in the ground soil were taken into account. By using the data over a 6-month period the difference between calculated and measured RH in crawl space air was minimised. The calculated results when

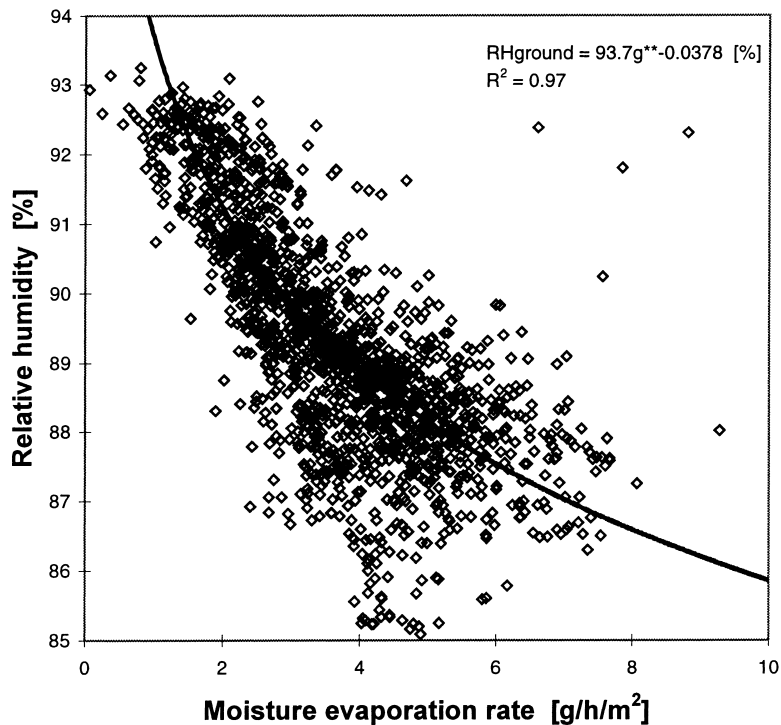

Fig. 7. The correlation between measured relative humidity on the ground and moisture evaporation.

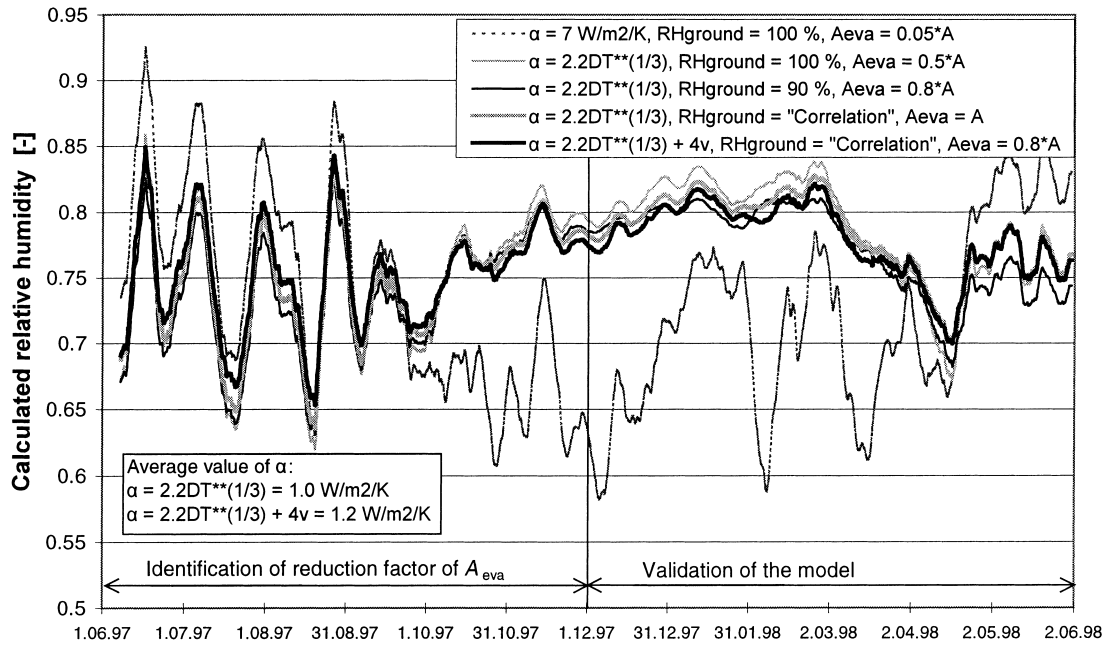

Fig. 8. Calculated weekly averages of relative humidity in crawl space air. Heat transfer coefficient, ground surface RH and area (A is area of crawl space) are varied. The ‘correlation’ is shown in Fig. 7.

Eq. (11) or (12) and the correlation for RH on the ground is used or not are shown in Fig. 8.

The best agreement with measured RH was achieved when the convective heat transfer coefficient was calculated with Eq. (12) and for RH on the ground the correlation shown in Fig. 7 was used. This calculated RH, i.e. the last graph in Fig. 8, is compared with measured RH in Fig. 9. However, Eq. (11) gives results that are very close to Eq. (12)

and these seem to be physically correct since the reduction factor is equal to 1. Eq. (12) gives slightly higher values than Eq. (11) (1.2 and 1.0 W/m<sup>2</sup> K average value, respectively) and this explains the use of reduction factor 0.8 with Eq. (12). In Fig. 9, a period with a plastic sheet cover (that was applied in the test building), is taken into account by changing the reduction factor from 0.8 to 0.3. The reduction factor is not equal to zero with PVC, because it was

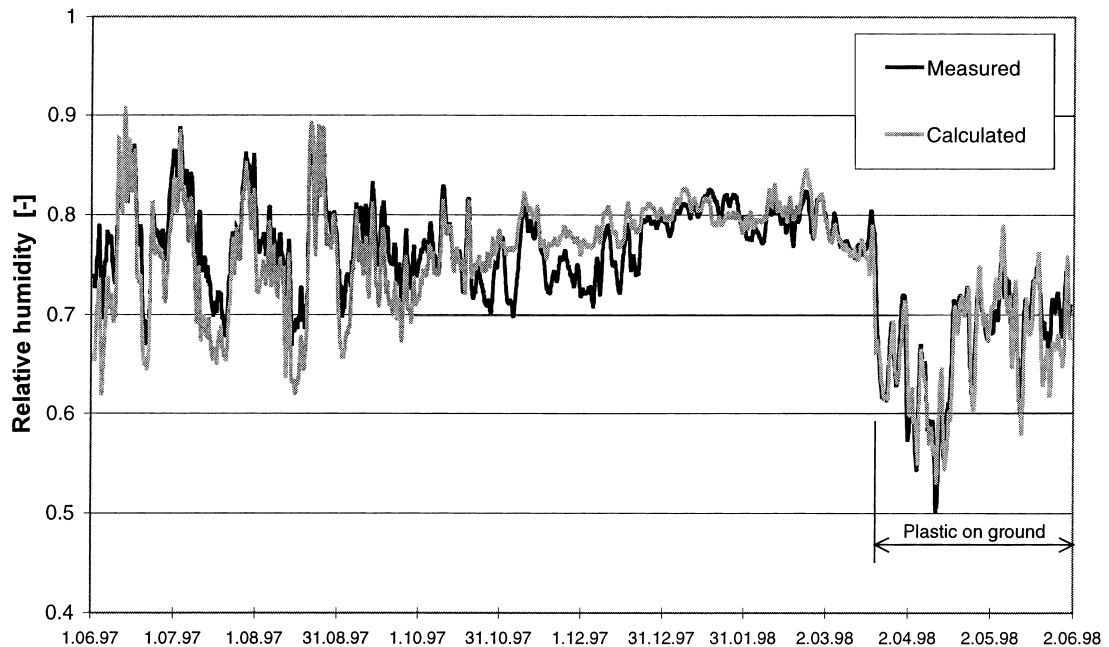

Fig. 9. Calculated and measured RH in crawl space air. The convective heat transfer coefficient is calculated with Eq. (12) and the RH on the ground surface from the correlation equation shown in Fig. 7 (24 h moving averages).



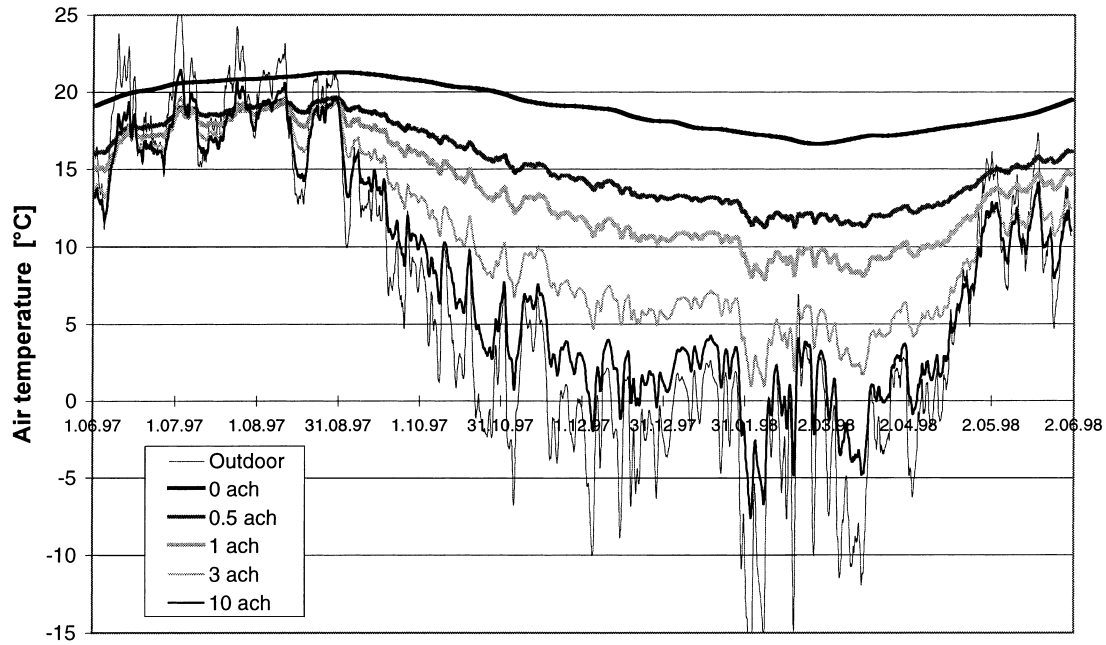

Fig. 10. The effect of air change rate on temperature in the crawl space air with uncovered ground (24 h moving averages).

determined in [5] that PVC reduced ground moisture evaporation by 70% only.

### 3.3. The effect of air change

The air change rate affects both the thermal and moisture behaviour of the crawl space and the resulting RH will be a sum of these. In addition to the general case, where it can be tested which air change rate leads to the lowest RH in the crawl space, two specific cases are worth to study. First, the effect of air change rate on temperature in crawl space is shown in Fig. 10. This is especially important in summer when thermal behaviour plays an important role. In the calculations, the correlation (Fig. 7) Eq. (12) and the reduction factor 0.8 are used. The temperature is highest in the crawl space with no ventilation. In addition to outdoor air, the heat of evaporation cools crawl space down. The effect of heat of evaporation may be about 2°C at 1 ach as shown later. This explains the high difference between temperatures in the 0 and 0.5 ach cases, as there is no significant evaporation in the 0 ach case due to equilibrium conditions. Secondly, it is useful to know that is the effect of air change rate on RH with zero ground moisture evaporation rate, i.e. with perfect moisture insulation on the ground. Fig. 11 shows that all air change rates give quite the same result in summer, but in winter high air change cools crawl space down and RH will rise. Zero ventilation gives here the lowest RH, but air change rates 0.5 and 1 ach brought about only small differences in RH. Figs. 10 and 11 demonstrate also the principle of unventilated crawl space application — an unventilated crawl space is warmest and driest in a cold climate if the moisture insulation is perfect.

The results with uncovered ground surface are shown in Fig. 12. In calculations, the correlation equation for RH on the ground surface shown in Fig. 7, Eq. (12) for convective heat transfer coefficient and the reduction factor 0.8 for evaporation area are used. The use of Eq. (11) with no reduction factor gave almost the same results except in the 10 ach case, where the RH was significantly lower compared to values in Fig. 12.

With uncovered ground the zero ventilation has brought about almost a saturated state. In summer, there is no upper limit for optimum ventilation, the higher the air change, the lower the RH, and in winter 2–3 ach shows the lowest RH. Corresponding moisture evaporation rates with uncovered ground surface are shown in Fig. 13. The relation between air change rate and evaporation rate is not linear; there is certain flexibility in moisture evaporation, i.e. higher air change rates have clearly increased the evaporation rate.

### 3.4. The effect of moisture and thermal insulation on the ground

Ground covers are used to reduce the ground moisture evaporation. Moisture resistance of ground cover affects both moisture and thermal behaviour in crawl space, as reduced moisture evaporation will raise crawl space temperature due to reduced heat of evaporation. The thermal insulation of ground cover will bring about extra effects in thermal behaviour. In the following, the effects caused by a 5 cm layer of expanded polystyrene (EPS), and plastic sheet (PVC) are studied. The results are calculated with the material properties shown in Table 1, and Eq. (9) is used

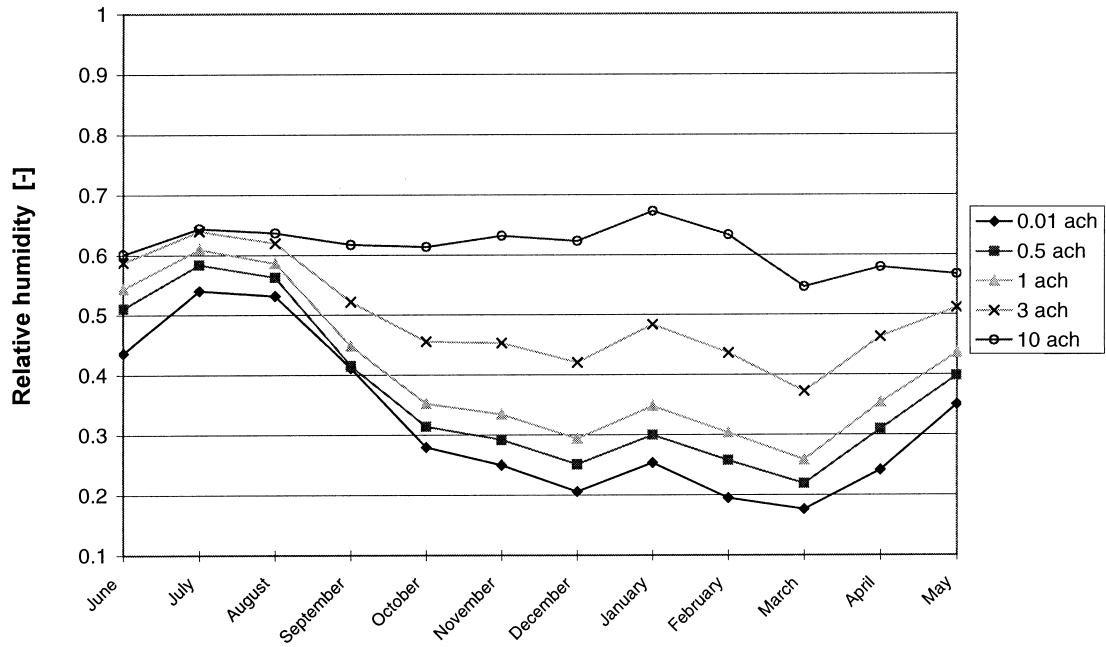

Fig. 11. The effect of air change rate on RH (monthly average values) in the crawl space air with a zero ground moisture evaporation rate.

for moisture transfer in ground cover. In the case of PVC that is assumed to be vapour-tight, the moisture flow through it is equal to zero. On the lower surface of EPS the humidity by volume corresponding to 100% RH is used as boundary condition.

Temperatures in crawl space with and without ground cover at air change rate 1 ach are shown in Fig. 14. Notably higher temperature can be seen especially in summer when the insulation is applied. However, the temperature rise is caused mainly by reduced moisture evaporation, which was

with insulation  $0.34 \text{ g/m}^2 \text{ h}$  and with uncovered ground  $3.4 \text{ g/m}^2 \text{ h}$ . The effect of evaporation heat on the air temperature can be seen when the PVC (no evaporation) is compared to uncovered ground. Air temperature with a PVC-sheet is lower in summer and higher in winter compared to EPS-insulation. Thus, the insulated heat capacity of the ground will increase the temperature in summer, but in winter the temperature will decrease. Due to reduced thermal mass, the crawl space temperature accords slightly more with the outdoor temperature.

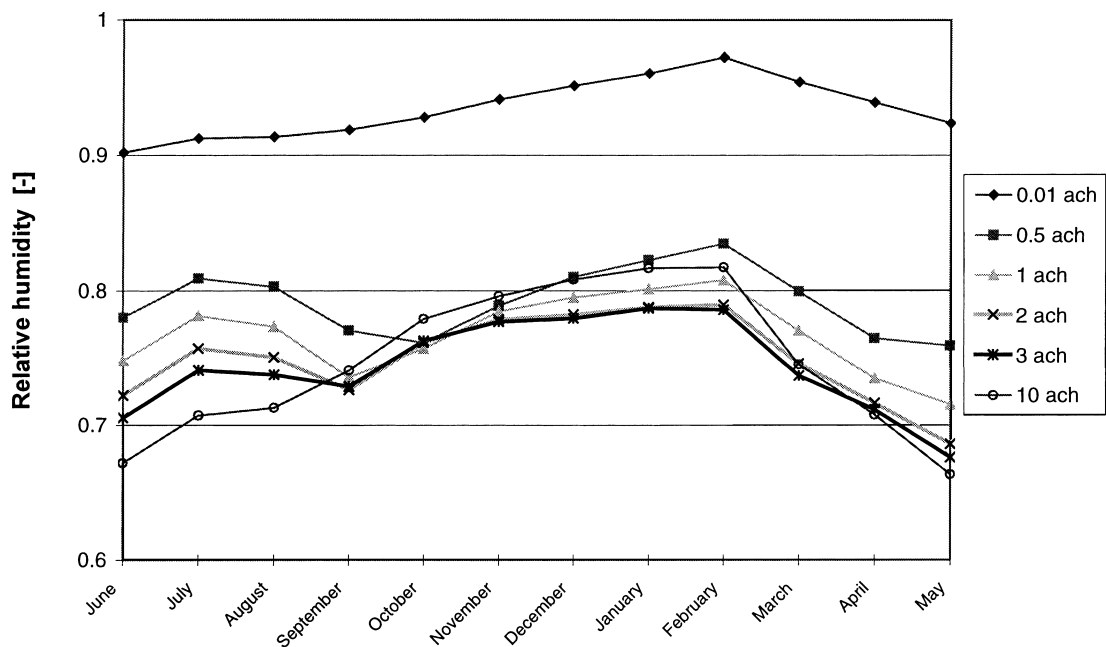

Fig. 12. The effect of air change rate on RH of crawl space air when the ground surface is uncovered.

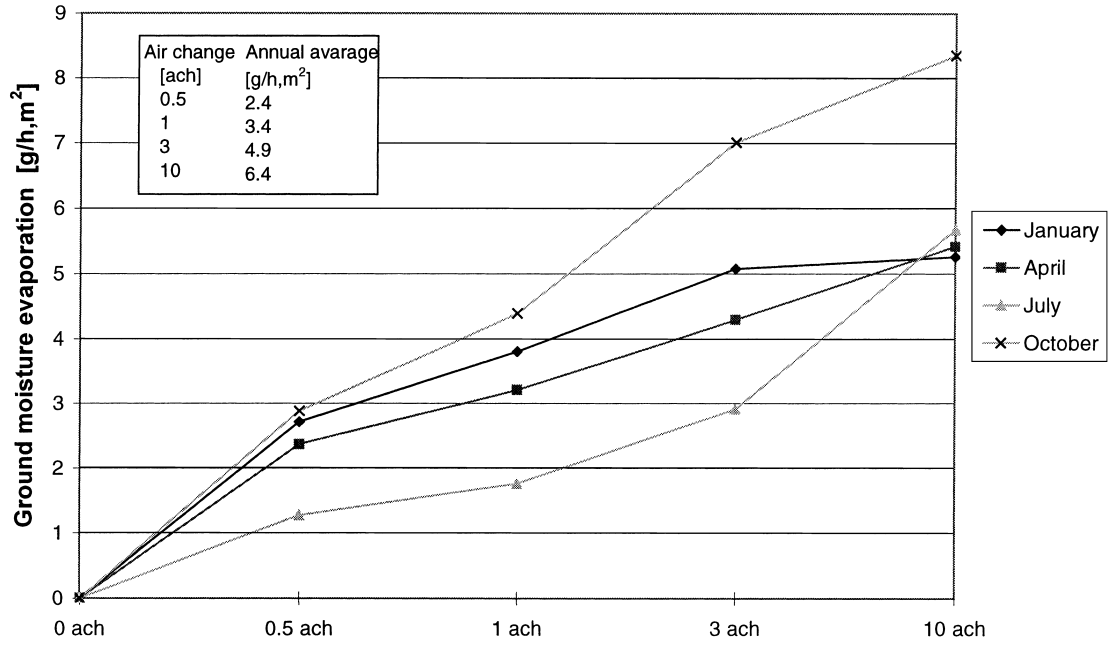

Fig. 13. Ground moisture evaporation rate as a function of air change for uncovered ground.

Relative humidity in crawl space air is shown in Fig. 15. RH with EPS-insulation and PVC on the ground is very low in the heating season because of effectively reduced moisture evaporation. In summer, when outdoor air is moist and warm, the effect is less, but still significant as RH remains clearly under 80%. In summer, the EPS-insulation gives slightly lower RH than PVC-sheet.

The effect of air change rate on RH with EPS-insulation on the ground is shown in Fig. 16. These results can be compared to the results calculated with vapour-tight ground

cover shown in Fig. 11. Here the optimum air change rate is about 0.5 ach and RH is almost the same within the range 0.2–1 ach. Within this range monthly averages are less than 60%. High air change rates brought about slightly higher RH because crawl space was cooled down. Unventilated crawl space shows the highest RH because used EPS-insulation is not completely vapour-tight. Still, the ground moisture evaporation rate is by about 90% lower compared to uncovered ground, the average value is 0.4 g/h m<sup>2</sup> with 0.5 ach, 0.34 g/h m<sup>2</sup> with 1 ach, and about 0.3 g/h m<sup>2</sup> with 3 and 10 ach.

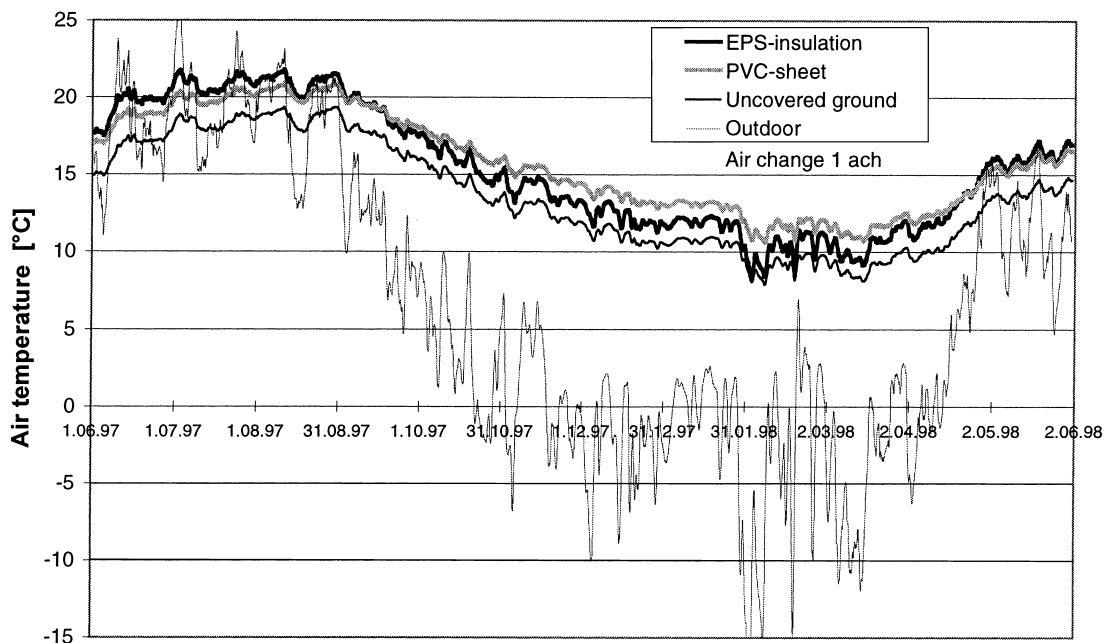

Fig. 14. The effect of thermal insulation and the evaporation heat on air temperature in the crawl space. Air change is constant, 1 ach (24 h moving averages).

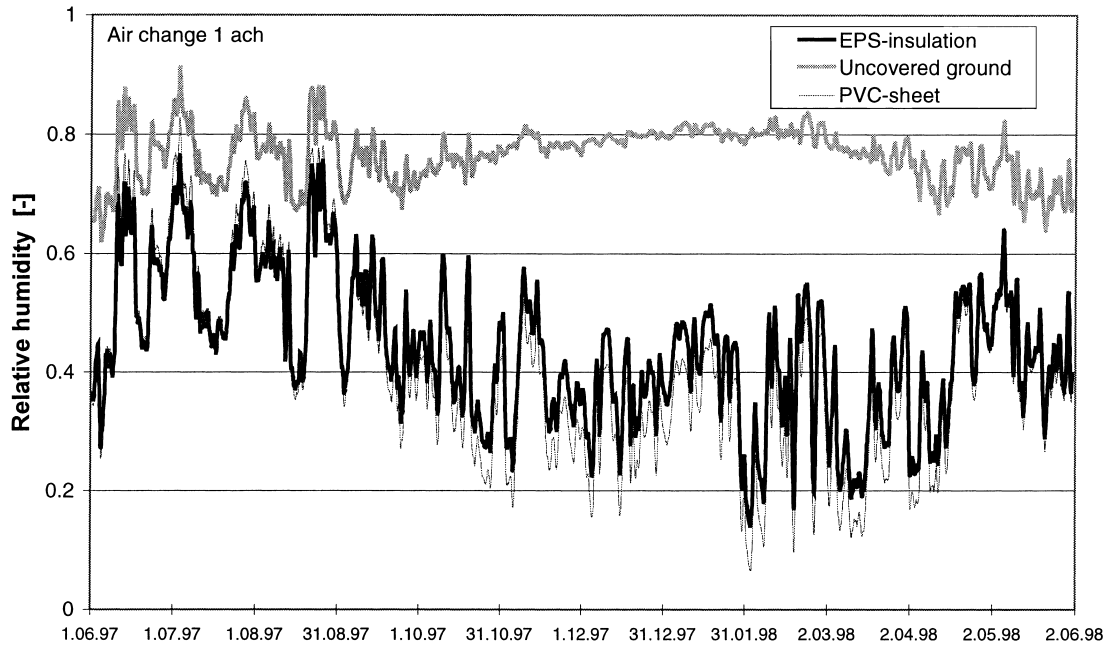

Fig. 15. Relative humidity in the crawl space air when ground covers (5 cm EPS and PVC) are applied. Air change is constant, 1 ach (24 h moving averages).

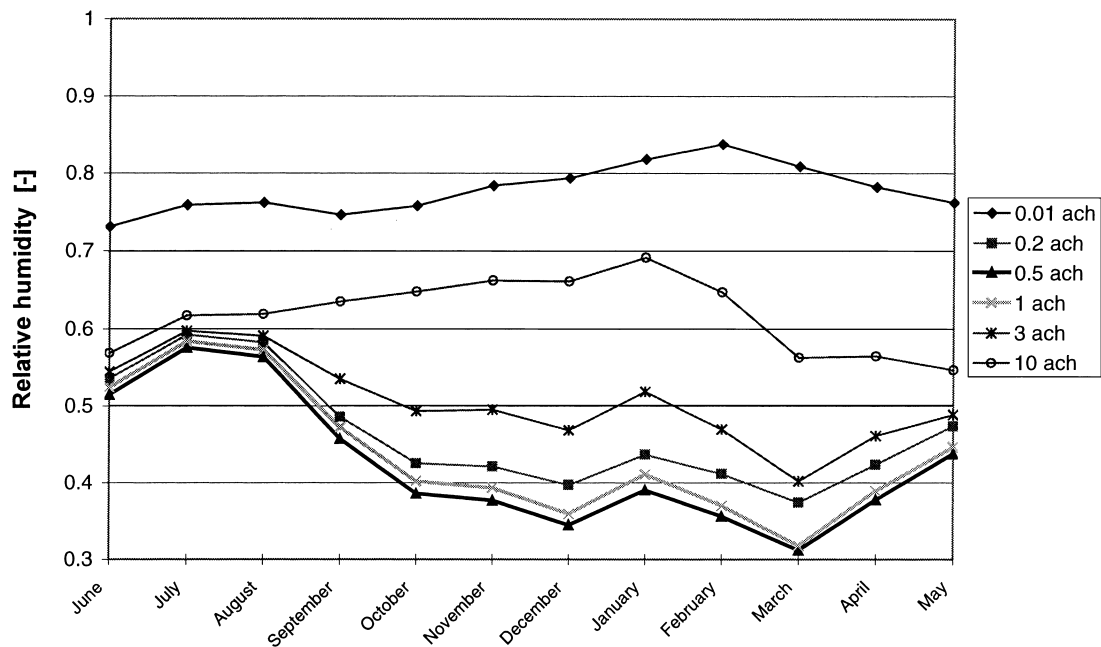

Fig. 16. The effect of air change rate on relative humidity with 5 cm EPS-insulation on the ground.

#### 4. Discussion

When the calculated and measured results are compared, uncertainties in the field measurements and model simplifications should be taken into account. These uncertainties were crawl space leakage in air change measurements and the measuring of RH on the ground surfaces. The air change measurement was continuous; it was based on the measure-

ment of pressure difference across ventilation pipes that indicates only the air flows in ventilation pipes, i.e. possible leakage was not taken into account. However, this underestimation of the air change rate cannot be significant because it would affect crawl space temperature in opposite directions in summer and winter — so this disagreement was not recognised. The measurement of  $T$  and RH on the ground surface was complicated due to the probe dimensions; the

diameter of that was 10 mm. The probe was pushed by half into the soil to get readings on the surface. When calculated temperatures are compared with the measured ones, a good agreement in crawl space air temperatures can be seen, the deviation is usually less than  $0.5^{\circ}\text{C}$ . Agreement in temperatures on the ground was reasonable as well; however, slightly higher differences can be seen. It is notable that two different methods of calculating heat transfer from the inner area of crawl space (circular arc or a 10 m ground layer having a constant temperature on bottom) gave almost the same result. Good agreement between measured and calculated values shows that simplifications made in the ground heat transfer are justifiable. The simplified moisture model that did not include moisture storage in the ground, floor and walls showed a good performance in the building studied. In this particular case, the effect of moisture storage was not significant since the moisture capacity of materials present in crawl space (concrete, expanded polystyrene) was low. It can be said that the model served a purpose: it was possible to calculate the crawl space RH with a difference of less than 5% when daily average values are considered. It should be noted that all results discussed in this paper apply only to apartment buildings with relatively warm crawl spaces in a cold climate. The results cannot be generalised for other building and climate types.

Ground moisture evaporation from uncovered ground is in general problematic to calculate. Calculation from the surface by mass transfer coefficient is valid when the ground surface is wet, i.e. when moisture transport in the soil is larger or equal to the evaporation. For relatively dry ground soil the evaporation capacity is larger than moisture transport in the soil and it is necessary to take the last into account. For example, the equation used for ground covers can be applied if saturated conditions are assumed at a certain depth in the ground and the moisture permeability of the upper ground layer is known. In practice, a strongly simplified approach, where moisture transport in soil is taken into account by constant reduction factor of evaporation rate, is quite often used. The problem is that there are no generally applicable reduction factors because these depend strongly on the moisture condition of the ground soil, which can vary highly in different building sites.

In the test building the RH on the ground surface varied between 85–100%. When this was taken into account by the determined correlation, it was possible to calculate moisture evaporation from the mass transfer coefficient without using any reduction factor (when traditional Eq. (11) was used for the convective heat transfer coefficient). This demonstrates that the moisture transport in the soil was approximately equal to the evaporation and probably only the very thin surface layer of ground was not saturated. When the Eq. (12) was used for  $\alpha$  (to take air movement in the crawl space into account) it increased the average value of  $\alpha$  from  $1.0$  to  $1.2 \text{ W/m}^2 \text{ K}$  and the reduction factor 0.8 had to be used to maintain the agreement between measured and calculated values. When 100% RH on the ground surface was assumed,

a reduction factor 0.5 had to be used. In general, all cases with a calculated convective heat transfer coefficient showed rather the same results when reduction factor was chosen by parameter identification. The only case with a strong disagreement was the case with the constant heat transfer coefficient.

The average value of calculated convective heat transfer coefficient on the ground surface,  $1.0\text{--}1.2 \text{ W/m}^2 \text{ K}$ , is rather low when compared to other studies. Elmroth recommends in [14] a constant heat transfer coefficient  $7 \text{ W/m}^2 \text{ K}$ , but at the same time the reduction factor 0.1 that makes for the resulting coefficient 0.7. Åberg reports in [15] that in an outdoor air ventilated crawl space  $a$  varies during the year between  $1.5$  and  $6.0 \text{ W/m}^2 \text{ K}$  holding the minimum value during summer, and for unventilated crawl spaces  $\alpha$  is equal to  $1 \text{ W/m}^2 \text{ K}$ . Rantamäki reports in [16] only the resulting moisture transfer coefficient ( $\beta$  in Eq. (8), no reduction factor) corresponding to the  $1.7 \text{ W/m}^2 \text{ K}$  heat transfer coefficient for clay and  $1.3\text{--}1.5 \text{ W/m}^2 \text{ K}$  for gravel. In general, it seems that  $a$  may vary significantly depending on conditions in different crawl spaces, and thus the ‘general’ values will be very approximate.

Calculated results prove that moisture behaviour in crawl spaces is most critical in summer. Results show that unventilated crawl space was warmer than a ventilated one and ventilation cooled crawl space down especially in the heating season. The temperature behaviour determined the moisture behaviour completely if ground moisture evaporation was entirely prevented. In this case, RH remained lowest with no ventilation, but it remained quite the same within the range 0–1 ach. This demonstrates the basis for an unventilated crawl space application — if the moisture evaporation is entirely prevented the crawl space may be left unventilated. Still, a low air change rate such as 0.5 ach (or 1 ach) does not alter the situation much and may be useful for minimizing risks (such as leakage in moisture insulation).

In crawl spaces with a moist ground surface having no ventilation at all leads to almost saturated air, because the crawl space air reaches an equilibrium with the humidity on the ground. The results show a certain flexibility of moisture evaporation — the higher the air change rate, the higher the evaporation rate. Still, higher air change rates decreased RH in the crawl space air despite the rise in evaporation. In winter, a clear optimum air change rate 2–3 ach was found because excessively high air change cooled the crawl space down and raised RH. In summer, the upper limit for optimum ventilation was not encountered, because the highest calculated air change rate 10 ach gave the lowest RH. It should be noted that the calculations were made for a relatively warm crawl space in the apartment building. As in detached houses the crawl space temperatures are usually lower, for example a 3 ach air change during winter might cool the crawl space down unnecessarily.

Ground covers having thermal insulation appear to be more effective than covers without insulation. The studied

5 cm layer of expanded polystyrene with low density had a large enough moisture resistance to reduce moisture evaporation by about 90% compared to the uncovered ground. In practice, some evaporation might occur through the joints and other leakage points, but this will be removed effectively by ventilation. Another ground cover with corresponding properties would probably be a lightweight expanded clay aggregate layer with a thickness of 10–30 cm. The most important effect of insulation is the rise in temperature especially in summer by 2–3°C compared to uncovered ground. However, most of the temperature rise was caused by reduced moisture evaporation, yet about 1°C in summer was clearly the result of insulating the cold ground surface from the crawl space. Higher crawl space air temperature in summer reduced its RH to a very low level — the monthly average values did not exceed 60%. In winter, the air temperature with insulation was by 1–2°C lower when compared to the PVC-sheet, but was still by 1–2°C higher when compared to uncovered ground. The studied expanded polystyrene needs about 0.5 ach air change, which will most effectively remove 0.3–0.4 g/h m<sup>2</sup> moisture evaporation. The performance was almost the same with 1 ach, and the range 0.5–1 ach can be recommended in practice as it is enough to remove possible leakage through joints.

## 5. Conclusions

1. The developed model served a purpose, as it was possible to calculate the relative humidity in crawl space air with less than a 5% difference compared to the measured data when daily average values are considered. This demonstrates that there are bases for simplifications made in heat transfer in the ground as well as for using a convective heat transfer coefficient in the evaporation calculations for the uncovered ground surface. The results calculated apply for apartment buildings in a cold climate only and they cannot be generalised for other building and climate types.
2. The ground moisture evaporation and the thermal behaviour are the key elements determining the resulting relative humidity in the crawl space. If moisture evaporation is entirely prevented, the crawl space may be left unventilated — an unventilated crawl space is warmest and driest in a cold climate. In other cases, ventilation is always required to remove moisture. Otherwise all the crawl space will reach an almost saturated state, an equilibrium with humidity on the ground.
3. The higher air change rates increased the moisture evaporation from the uncovered ground surface but still brought about lower relative humidity. Raising the air change from 0.5 to 3 ach increased ground moisture evaporation from 2.4 to 4.9 g/m<sup>2</sup> h and decreased the highest monthly average of relative humidity in summer from 81 to 74%. For the uncovered ground surface a

clear optimum air change rate 2–3 ach was found in winter. In summer, there was no upper limit for ventilation, the higher the air change the lower the relative humidity. At 2–3 ach air change rate the monthly average values of relative humidity remain under 80%.

4. Ground covers are the most effective measures to reduce relative humidity in the crawl space. Computational vapour-tight ground cover increased crawl space temperature by about 2°C, which represented the effect of the missing evaporation, and decreased relative humidity to below the 60% level within an air change range 0–1 ach.
5. Ground cover with thermal insulation is in principle more effective than ground cover without insulation as it produces a higher temperature rise in summer. The calculated 5 cm expanded polystyrene on the ground reduced moisture evaporation by about 90% to 0.3–0.4 g/m<sup>2</sup> h, increased the crawl space temperature by 2–3°C in summer and decreased relative humidity below the 60% level.
6. For crawl spaces of apartment buildings with a ground cover can be recommended 0.5–1 ach air change which can effectively remove moisture evaporation through the ground cover, by its joints and any other leakage points.
7. An outdoor air ventilated crawl space demonstrated very high performance in the building type studied, i.e. in apartment buildings with relatively warm crawl space, when a ground cover was applied. The relative humidity of crawl space air did not cause mould growth even in the case of uncovered ground if the proper air change rate 2–3 ach was applied. However, uncovered ground surface cannot be accepted even in this case, because if any nutrients are present the mould growth will occur due to high relative humidity on the ground surface.

## Acknowledgements

The Finnish Ministry of the Environment is gratefully acknowledged for sponsoring this project. The authors would like to thank Prof. Kai Siren and Prof. Olli Seppänen for their valuable comments.

## References

- [1] I. Samuelson, Moisture control in crawl space, ASHRAE Tech. Data Bull. 10 (3) (1994) 58–64.
- [2] O. Åberg, The unventilated crawl-space foundation, Heat and moisture transfer in buildings — research papers 1990, Lund Institute of Technology, Report TVBH-3016, Lund, 1991, pp. 41–45.
- [3] C.E. Hagentoft, L.E. Harderup, Temperature and moisture conditions in a crawl space ventilated by indoor air, in: Proceedings of the 3rd Nordic Symposium 'Building Physics '93', Vol. 1, 1993, pp. 261–268.
- [4] J. Kurnitski, Crawl space air change, heat and moisture behaviour, *Energy Build.* 32 (1) (2000) 19–39.

- [5] J. Kurnitski, Ground moisture evaporation in crawl space, *Build. Environ.*, accepted for publication, 1999.
- [6] W.B. Rose, A. TenWolde, Issues in crawl space design and construction — a symposium summary, *ASHRAE Technical Data Bull.* 10 (3) (1994) 1–4.
- [7] L.E. Nevander, B. Elmarsson, Fuktdimensionering av träkonstruktioner, Riskanalys, Swedish Council of Building Research, Report R38, 1991.
- [8] L.E. Nevander, B. Elmarsson, Fukt Handbok praktik och teori (Handbook of moisture, practice and theory), AB Svensk Byggjänst, Stockholm, 1994 (in Swedish).
- [9] P. Sahlin, E.F. Sowell, The Neutral Model Format for Building Simulation, Stockholm, 1996.
- [10] P. Sahlin, NMF Handbook, An Introduction to the Neutral Model Format, NMF version 3.02, Stockholm, 1996.
- [11] O. Vuorelainen, The temperatures under houses erected immediately on the ground and the heat losses from their foundation slab, Technical Research Centre of Finland, VTT Publications 55, Helsinki, 1960.
- [12] C.E. Hagentoft, Heat loss to the ground from a building, Slab on the ground and cellar, Lund Institute of Technology, Report TVBH-1004, Lund, 1988.
- [13] M.J. Lampinen, Aineensiirto-oppi (Mass transfer), Helsinki University of Technology, Laboratory of Applied Thermodynamics, Report 94, Otaniemi, 1996 (in Finnish).
- [14] A. Elmroth, Kryprumsgrundläggning (Crawl space foundation), Construction Research, Report 12, Stockholm, 1975 (in Swedish).
- [15] O. Åberg, CICS, Calculation in crawl spaces, in: *Proceedings of the 3rd Symposium on Building Physics in the Nordic Countries*, Copenhagen 13–15 September, 1993, pp. 579–586.
- [16] J. Nieminen, J. Rantamäki, Tuulettuva alapohja (Ventilated floor), Technical Research centre of Finland, Research Notes 1241, Espoo, 1991 (in Finnish).