

Original article

Analysis of log shape and internal knots in twenty Maritime pine (*Pinus pinaster* Ait.) stems based on visual scanning and computer aided reconstruction

Isabel Pinto^{a*}, Helena Pereira^b and Arto Usenius^a

^a VTT Building and Transport, PO Box 1806, 02044 VTT, Finland

^b Centro de Estudos Florestais, Instituto Superior de Agronomia, 1349-017 Lisboa, Portugal

(Received 1 February 2001; accepted 21 January 2002)

Abstract – A mathematical reconstruction of Maritime pine (*Pinus pinaster* Ait.) was produced using the WoodCim[®] software based on input information obtained by image scanning of twenty 83 years old stems sampled in Portugal. The application of the reconstruction software resulted in 3D and 2D representations for logs and trees that allowed the visual appraisal of external shape as well as of the internal knot architecture. Information on tree geometry (i.e. taper) and knot parameters (i.e. knot length, diameter and volume) and on their variation with tree height could be obtained from the reconstructed logs and stems and may be incorporated in sawing yield studies through simulation as well as in raw material characterisation studies. In the studied trees, the average volume percentage of knots varied from 0.07% for butt logs to 1.95% for top logs. The knot core represented, in % of the tree radius, from 28% at the stem bottom to 84% at 70% of total tree height.

maritime pine / modelling / wood quality / knot dimensions / image analysis

Résumé – Caractérisation de la forme des fûts et des noeuds dans 20 arbres de pin maritime (*Pinus pinaster* Ait.) après analyse d'image et reconstruction par logiciel. La reconstruction mathématique d'arbres de pin maritime (*Pinus pinaster* Ait.) a été faite avec le logiciel WoodCim[®] ayant pour base l'information obtenue par l'analyse d'image de vingt fûts de 83 ans échantillonnés au Portugal. L'application des modèles de reconstruction a produit des représentations en 3D et 2D des fûts et billes qui ont permis l'appréciation visuelle de leur forme et de l'architecture intérieure de la nodosité. Des données sur la géométrie de l'arbre (i.e. décroissance de la tige) et les caractéristiques des noeuds (i.e. longueur, diamètre et volume), ainsi que sur leur variation en hauteur dans l'arbre, ont pu être obtenues à partir de la reconstruction, permettant leur incorporation dans des études d'optimisation de sciage par simulation ou de caractérisation de la qualité du bois. Dans les arbres étudiés, le volume de noeuds a varié de 0,07 % pour les billes de pied jusqu'à 1,95 % pour les billes de cime. Le centre noduleux a augmenté de 28 % du radius à la base, jusqu'à 84 % à 70 % de la hauteur totale.

pin maritime / modélisation / qualité du bois / dimension des noeuds / analyse d'image

1. INTRODUCTION

Maritime pine (*Pinus pinaster* Ait.) spreads naturally in the Mediterranean regions of France, Spain and Italy (subspecies *pinaster*) and in the Atlantic influenced regions of Portugal, Spain and France (subspecies *atlantica*). In the last decades this species was introduced with success in plantations in South Africa, New Zealand and Australia. In Portugal, it is the most important species with more than 1 million ha (ca. 30% of the total Portuguese forest area) concentrated mostly in the central part of the country. Pinewood is the primary raw material for the saw milling, particleboard and plywood industries. The main uses concerns sawn timber products.

The optimising of the activities in the wood conversion chain, from the forest producers to the sawmills, secondary wood processing industries and further to the consumers of the

final products, requires modelling and simulation tools producing information for selection and processing of the wood raw material. In the sawmill, computer simulation provides the possibility to obtain information on different production options for a set of logs.

In this context the recent development of wood scanning technology and the progress in research on defect detection have contributed to tree modelling and sawmilling optimisation and simulation procedures [6, 22, 27, 28]. The mathematical reconstruction of logs and trees based on scanning technology can now provide accurate 3-D representations and detailed information regarding geometry of stems and internal defects, especially of knots. Knots are the main cause for sawn timber down-grading particularly due to their effect on warping, mechanical properties and aesthetics. For Maritime pine, Machado [12] reports that knots count

* Correspondence and reprints
Tel.: +358 9 456 5565; fax: +358 9 456 7027; e-mail: isabel.pinto@vtt.fi
© INRA, EDP Sciences, 2003

Table I. Characteristics of the plot (279th plot from Leiria Forest) and of the 20 sample maritime pine trees (mean and standard deviation).

Plot characteristics		Characteristics of the sample trees		
			Mean	SD
Site index ⁽¹⁾	DH (50)> 20 m	Total height (m)	28.8	2.8
Age	83 years	Crown height ⁽⁶⁾ (m)	8.7	2.6
Basal area	25.1 m ² ha ⁻¹	Height to first dry branch (m) ⁽⁷⁾	16.0	2.1
Density	171 trees ha ⁻¹	DBH (cm)	47.8	7.3
DH ⁽²⁾	23.6 m	Bark thickness at DBH	3.4	0.7
DDBH ⁽³⁾	47 cm	Volume over bark (m ³) ⁽⁸⁾	2.7	0.7
Regeneration	seedling	Volume under bark (m ³) ⁽⁸⁾	2.3	0.6
Thinning ⁽⁴⁾	low thinning			
Pruning ⁽⁵⁾	up to height of 2 m			

(1) Dominant height (DH) at 50 years; (2) dominant height; (3) dominant diameter at breast height; (4) first thinning at 15 yr, last at 58 yr, mostly with a 5 yr period; (5) pruning till 2 m high maximum till 15 yr; (6) crown height = total height - live crown base height; crown base at the simultaneous occurrence of 2 green branches; (7) height from tree base to the first visible dry branch; (8) precise cubic method, Smalian formula.

50% of the rejections in the grading for structural uses and for 44% of downgrading in visual strength grades. Characteristics of internal knots such as knot quality, length and diameter distributions, decisively contribute to the value yield from log sawing.

Studies on knottiness have been carried out recently by several authors for Scots pine (*Pinus sylvestris* L.) and Norway spruce (*Picea abies* (L.) Karst.) using different techniques: direct measurements of the knot parameters in whorls [19, 29, 30], peeling methods to produce veneer strips, further measured with an electronic device [11], CT-scanning technologies [1, 2, 13, 17] and inventory data and predicting models [3, 4, 7, 14–16]. For Maritime pine (*Pinus pinaster* Ait.) knottiness has been studied through crown architecture and external branch measurements but very few data have been published [8, 9, 18, 26]. Neither are data available in the literature for this species concerning the internal knots properties and log modelling based in new scan technologies.

This paper presents the application of a 3D-computer-aided stem and log reconstruction software, based on input information obtained by image scanning, to twenty 83 years old Maritime pines. The stem/log reconstruction is a software module designed to serve as input data for sawing simulation within WoodCim[®], an integrated optimising software system developed by the VTT Technical Research Centre of Finland for Scots pine and Norway spruce and comprising several modules to model the whole conversion chain from forest to end products [27, 28]. The procedures used for converting real logs, and their internal knots, into virtual representations are described. The results obtained with this reconstruction are the shape of log/stem and knot parameters such as length diameter and volume which will be used to analyse the variation of the internal knottiness within the 20 Maritime pine stems.

2. MATERIALS AND METHODS

2.1. Tree sampling

Twenty Maritime pine (*Pinus pinaster* Ait.) trees were randomly sampled from a stand in Portugal, the Leiria pine forest. This forest is

situated in central coastal Portugal (39° 45' 00 N, 8° 55' 60 W WGS 84, 113 m a.s.l.), under strong Atlantic influence with constant North and Northwest winds. Mean air temperature varies between 12.5 °C and 15 °C, relative air humidity between 80 and 85% and yearly rainfall values are usually between 700 mm and 800 mm [5] The trees were sampled from an 83-year-old even-aged plot. *Table I* shows the main plot characteristics as well as the biometric data for the sampled trees [10, 20].

After harvesting, total height, crown height and height of the first visible dry branch were measured for each tree. The base of the living crown was located between 60% and 80% of total tree height and the first visible dry branch was located in 70% of the trees between 45% and 60% of total tree height and the remaining above this level. Two cross diameters (N-S, W-E) were measured every 2.5 m along the tree and bark thickness was determined with a bark gauge in the position of largest thickness. Detailed information about the sampled trees can be found at Pinto [20].

2.2. Mathematical reconstruction of logs and stems

Each tree was crosscut into 4 logs, each 5-m long (*figure 1a*). In the cross sections of each log, a line was drawn in the North-South direction through the pith. The logs were sawn into 25-mm thick flitches with the North-South line perpendicular to the saw blade. Each flitch/slab was marked with a code to identify its position in the log, in the tree and the North and South sawing surfaces.

The flitches were scanned in VTT using the WoodCim[®] inspector scanning system providing RGB (colour component) information stored in the computer files (24 bit bmp format) for further processing and analyses (*figure 1b*). The scanned images were computed by VTT's PuuPilot software. With assistance by the operator and with the image of the flitch on the screen, the system registered the geometrical outline of the sawing surface, the log pith line and the location, size, shape and quality factor of each knot (*figure 1c*). Knots were registered in the sawed flitch surface as well as in the edge and slab surfaces (surface knots). Each measurement was registered in data files as xy co-ordinates. The slab thickness measured during scanning was also introduced in the slab data file [24].

The data concerning the geometric and knot features of the individual flitch files pertaining to one log were processed with the WoodCim[®] module software for the mathematical reconstruction of a log in a 3D system. The North-South line drawn on the top of logs before sawing was used as a reference line to join the flitches in their correct position and to create the z-coordinate (*figure 1d*). The stem was reconstructed by joining the different logs of a tree.

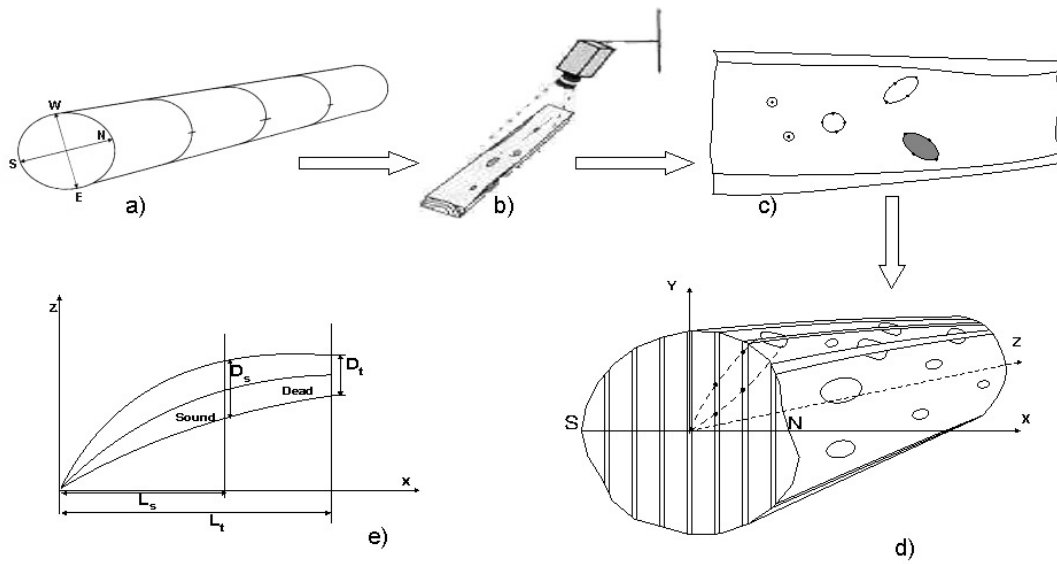

Figure 1. Log shape and internal knots reconstruction. (a) stem cross cutting into logs; (b) scanning of flitches; (c) marking knots on the flitch sawing surface; (d) log and knots reconstruction in the xyz co-ordinate system; (e) knot in the xz plane, total (D_t) and sound (D_s) knot diameter, total (L_t) and sound (L_s) knot length. (adapted from Song [24]).

With all flitches and slabs of a log assembled in the xyz co-ordinate system, the reconstructed log geometry was described with a series of cross-sections, each defined with 24 vectors calculated between the pith line points and the outline points of flitches and slabs. The saw kerf thickness used in the sawing of the logs was introduced between each two flitches [24]. Log taper was calculated using the geometric co-ordinates from the reconstructed log as the slope of the external line obtained from a mean radius calculated each 50-mm along all length. The radius is the average of all vectors that define each cross-section. Log reconstructed diameters were calculated as the double value of the average radius.

The 3D reconstruction of knots was based on the xyz co-ordinates of the knot points that were registered in the sawed surface of each flitch (figure 1d). These data allowed the calculation of individual knot parameters such as co-ordinates of knot origin on the log pith, knot orientation angle in the log cross section, knot length, quality zones (sound, dry and rotten) and a set of data for knot pith line and diameters of a series of knot cross-sections [23, 24]. The scanned images of all the flitches of the 4 logs from one tree containing a total of 245 knots were analysed manually to determine the number of knots and their origin position in relation to tree height. These values were compared with the reconstruction output.

2.3. Analysis of individual knot parameters

The data from the reconstructed saw logs and tree stems were transferred to the Oksa2000 software, developed at VTT, that automatically processes the information on the knots included in the reconstructed model. The programme uses as input the geometrical and knot data and gives as output: stem/log volume, individual knot volume (total and sound) and relative amount of knots in the total log/stem volume, and, for each knot, compass angle in the stem/log cross-section, diameter (total and sound) and length (total and sound), as shown in figure 1e. Knot volume was calculated as a sum of volumes from sections computed every 20 mm of knot length. These outputs were used to study the variation of knot length, diameter and volume with tree height level, calculated in % of total tree height in intervals of 5% of tree height.

3. RESULTS

The results obtained with the computer-aided reconstruction of logs are exemplified in figure 2 where the reconstitution of two logs (one butt and one middle log) is represented as a 3D view and as a 2D projection on the transverse plane.

3.1. Log shape

Log shape and taper are directly visualised in the reconstruction images and differences between logs may be qualitatively recognised, i.e. the butt swell and larger taper as shown in figure 2a.

The diameters obtained with the reconstructed model followed very closely the actual diameters of the logs measured in the field. The difference between modelled and field measured diameters was below 1% of the measured values except for the 20 m level where the modelled diameter was 4% higher than the measured diameter.

The top diameter for the 80 reconstructed logs varied from 15 cm to 52 cm, with 56% of the logs showing top diameters between 25 and 35 cm. Top diameters decreased with log position in the tree from an average 36 cm for butt logs to 24 cm for top logs (figure 3). Taper was 9 mm/m on average, ranging between 4 and 22 mm/m. Butt and top logs have the highest taper values, respectively 13 and 11 mm/m, while middle logs have taper values of 6 and 7 mm/m (figure 4).

3.2. Knot dimensions

The representation of the internal distribution of knots as reconstructed by WoodCim[®] allows to visualize their location along the log and radial extension, i.e. showing differences between logs in relation to proportion of knot-free wood (figure 2).

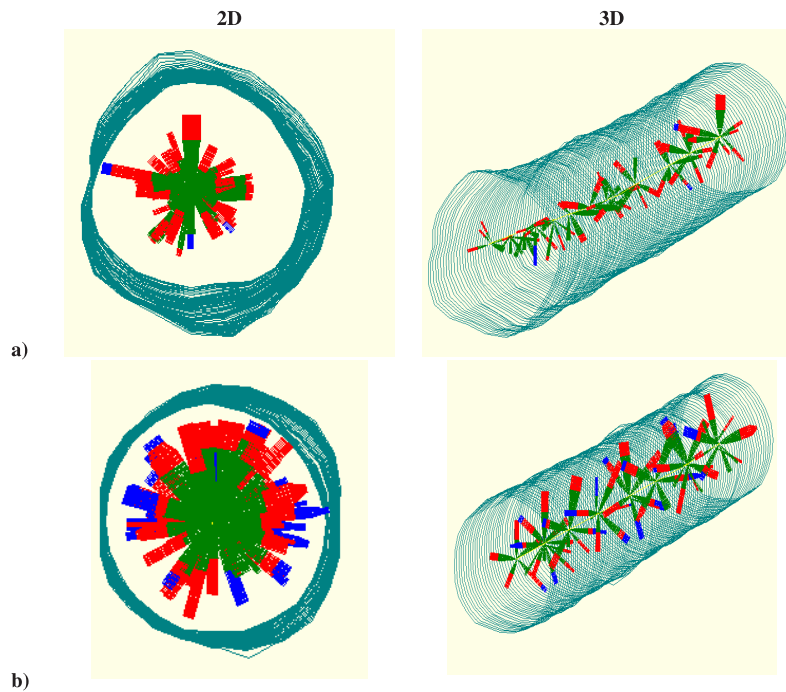

Figure 2. Mathematically reconstructed logs of maritime pine showing the geometry of the log and the internal knots in 2 and 3 dimensions. (a) butt log; (b) middle log.

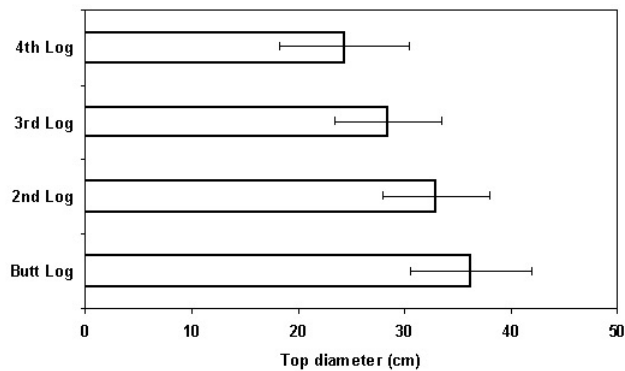

Figure 3. Top diameter for different log positions in the stem. Average and standard deviation (bar) of 20 logs.

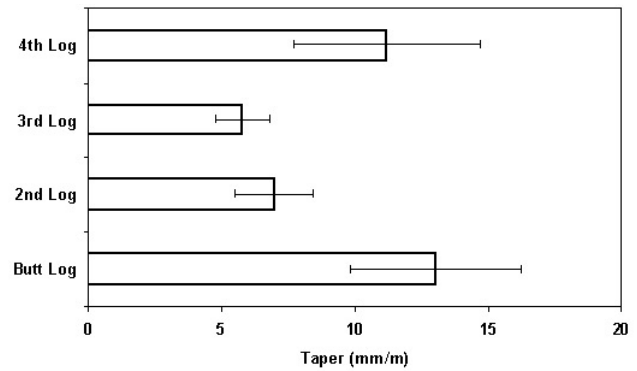

Figure 4. Log taper for different log positions in the stem. Average and standard deviation (bar) of 20 logs.

The accuracy of reconstruction in relation to number and position of knots was tested in 4 logs of one stem by comparing the model outputs with the direct measurements (table II). The number of reconstructed knots in each log differed from the reality only by 2 and the calculated positions for the knot origin on the log pith (Z co-ordinate of the origin point of knot pith) showed a mean deviation of 7.8 mm.

The proportion of total knot volume and sound knot volume in the total log volume as well as its variation with log position in the tree is shown in figure 5. The proportion of knots increases significantly from butt to top logs corresponding to 0.07 and 1.95% of log volume, respectively. The proportion of sound knots followed the same trend. The ratio of sound knots in the total knot volume is higher in butt and top logs than in middle

logs, the highest proportion of dead knots being found in the 3rd log (38%).

Figure 6 shows the variation of the total and sound knot core with tree height. The proportion of the tree cross section covered by the knot core increases strongly within the tree from stem base to the top: the total knot core represents 28% of the tree radius in the stem butt, and 84% at the stem top. The sound knot core shows the same type of variation, but the increase rate with tree height is slower when compared with total knot core. The variation is linear up to 50% of total tree height, the slope being higher for the total knot core. In the upper part of the stem, from 55% of total tree height upwards, the proportion of the knot core remains approximately constant at 85% and 65% of the tree diameter, respectively for the total and sound knot core.

Table II. Comparison of results given by the reconstruction of logs using WoodCim[®] and reality in relation to the number of knots and the Z coordinate of knot origin (height in the stem) as mean of deviations (real-reconstructed, in mm) and standard deviation, determined for the 4 logs of one stem.

Log position	Number of knots		Deviations of Z coordinate (mm)	
	Real	Reconstructed	Mean of deviations	SD
1st	56	54	5.4	4.4
2nd	41	39	6.6	6.0
3rd	76	78	9.8	9.2
4th	72	70	8.3	11.9
Stem	245	241	7.8	9.0

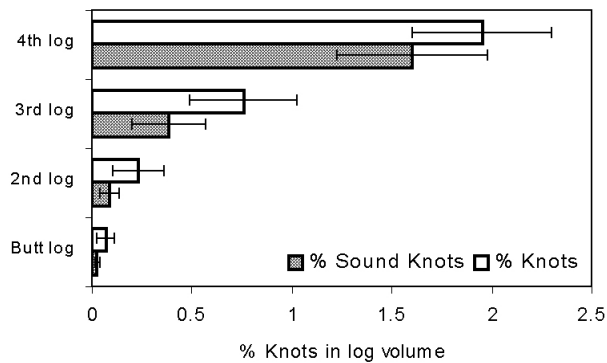

Figure 5. Proportion of the total knot volume and sound knots volume in the total log volume for different positions in the tree. Average and standard deviation (bar) of 20 reconstructed logs.

The variation of knot diameter, length and volume with tree height is presented in figure 7. Knot dimensions increase with tree height up to about 60% and after this level tend to stabilise or slightly decrease. Total knot length (L_t) increases from 5.7 cm at stem base to 12.4 cm at 55% of total tree height, decreasing then to the top. Sound knot length increases slowly in the lower part of the stem but faster after 40% of total tree height, reaching a maximum value of 9.5 cm at 60%. After that level it decreases slightly and at 80% of total tree height the sound knot length is close to the total knot length at this level (7.6 cm and 8.7 cm, respectively).

Total knot diameter (D_t) and sound knot diameter (D_s) increase almost linearly upwards up to 60% of total tree height where the maximum values are attained (3.2 and 3.6 cm, respectively). Between 60 and 80% of total tree height, D_t and D_s stabilise and the curves become close with only a 0.1 cm difference at 80% of total tree height.

The within tree variation of knot volume reflects the variation of knot length and diameter. Total (V_t) and sound (V_s) volumes increase very fast until 60% of total tree height (respectively 108 and 87 cm³) followed by a decrease to the top of the stem. The variation of knot volume, length and diameter with tree height could be mathematically described with polynomial functions that were fitted to the data with high correlation factors and statistical significance (table III).

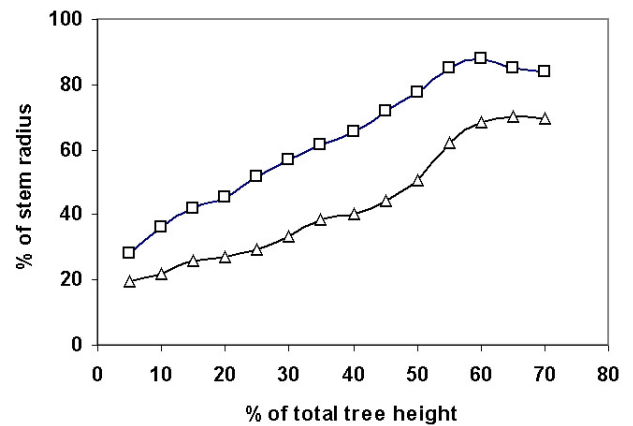

Figure 6. Total (□) and sound (Δ) knot core in percent of the stem radius. Average for the 20 trees.

4. DISCUSSION

The reconstruction model and knot calculation software (WoodCim[®] and Oksa2000, respectively) allowed a clear visualisation of important quality features of Maritime pine stems and their subsequent quantification, e.g. log geometry and knot parameters.

The reconstruction provided a good description for log shape with only small deviations between simulated and measured diameters (table II). The somewhat higher differences found for top logs result from the more irregular shape of stem at this level, already located in the dead crown area (i.e. the first dry branch was on average at 16 m of height) and with larger surface knots.

Concerning knots, the reconstruction was tested in relation to number of knots and location of knot origin on the stem pith on a sub-sample (total of 245 knots) and both results were good showing only minor differences between simulation and measurement (table II). Further analysis on larger samples is however required for a full validation of the accuracy of the reconstruction model. In fact, few results on large scale testing of reconstruction models, especially concerning the modelling of individual knots, have been published and most refer to small sample sizes or to comparison of measurement methodologies [17, 23].

In the present study the reconstruction of logs and stems allowed to obtain useful information to characterise the quality of the Maritime pine stems that were analysed. At this stage and with the limited number of trees studied, the information cannot be regarded as representing the diversity occurring for the species (i.e. of provenance, growth and management conditions). The trees studied here are probably to be included in the best quality assortments available in Portugal for the saw-milling supply. In fact, the state-owned Leiria forest where the trees were sampled is known as a good site for pine growth with a management oriented for high added value timber products, including 5 years rotation thinnings between 20 and 40 years of tree age, pruning before the first thinning and clear cutting at an approximate age of 80 years [5]. In most of the private-owned pine stands, the rotation is about

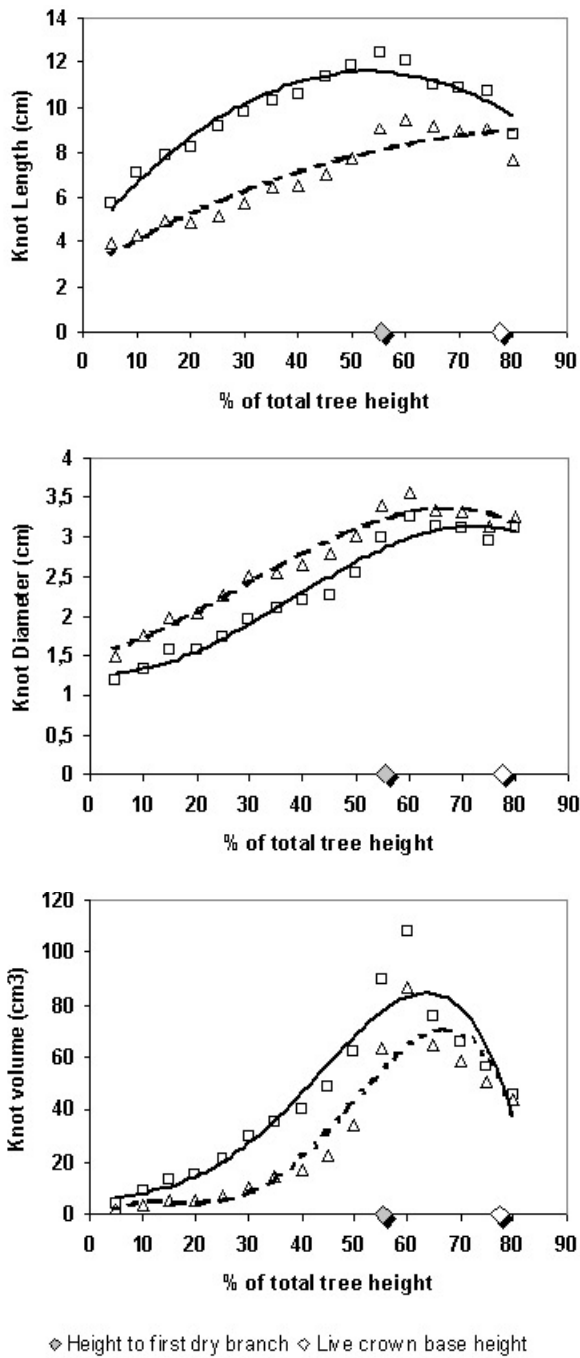

Figure 7. Total (\square) and sound (Δ) knot length, diameter and volume as a function of tree height, as the average for the 20 sampled trees. The corresponding polynomial fitted curves are indicated by (-) for total knot dimensions and by (--) for sound knot dimensions.

40 years, the forest is not managed and has no cultural operations [20]. A study made on the characterisation of Maritime pine logs in sawmills in different regions showed an average log diameter of only about 25 cm [21]. This is clearly below the average log diameter found here and corresponds to the diameters of top logs of the sampled trees (figure 3).

One important output parameter from the reconstruction of logs and stem refers to tree form, which is directly connected with log value, harvesting and processing costs and sawing yields. During conversion, log taper and diameter significantly impact on lumber yield and grade and on the size of the lumber to be produced [31].

The taper variation could be followed along the stem of the sampled Maritime pine trees (figure 4). For most logs taper is within the 6–11 mm/m values reported for Maritime pine logs [21] and butt-swell could be observed in the reconstruction output (figure 2). The middle logs presented the lowest taper values (figure 4), an indication of their potential to produce long structural lumber, when compared with butt and top logs. The taper increases in the top log resulting from the fact that at this height level (15–20 m) it is included in the dead crown zone. Maritime pine has a weak natural pruning and the death crown depth (often with big branches) is an important cause for depreciation of top logs [25].

The internal architecture of knots is clearly visible in the reconstruction images (figure 2). Since the outputs have different colours for sound and dead knots, an appraisal of knot quality distribution is directly appreciated which is not possible here in the black and white image.

The volume proportion of knots showed a strong increase with stem height (figure 5). The knot core also increased with tree height and remained rather constant in the upper part of the commercial stem (figure 6), corresponding approximately to the top log included in the dead crown (the first visible dry branch was located on average at 55% of total tree height). In the lower part of the stem, the knot core was small (on average 24% of the stem radius) and had the lowest proportion of dead knots. This stresses the importance of pruning Maritime pines at early stages since the tree has well branched first crown whorls and a weak natural pruning as referred above [25].

The within tree variation of knot dimensions could be followed, in average, up to 80% of total tree height, which represents the commercial section of the stem and therefore the most important in terms of value yield for timber products. Knot length and diameter increased along the stem attaining maximum values at approximately 60% of total tree height. The dimensional increase rate was higher in the 50–60% of total tree height, especially for diameter and volume (figure 7), probably a response to the thinnings that occurred when tree height corresponded approximately to the levels of 54 to 63% of the final total tree height. According to studies on mean annual height increments for this species [18], the thinnings were made when height increments were already in the decreasing phase allowing the tree to invest more in crown and diameter growth.

Knot dimensions have been related to tree diameter class in Scots pine [13, 14] and spruce [29]. This was also tested here, allowance made for the limited sampling and the fact that the stem within the living crown was not investigated. For the studied Maritime pines, the tree average knot total diameter and diameter at breast height showed a highly significant correlation ($r = 0.64$, $P = 0.0023$). Above the live crown level, knot size decreases with tree height according with previous studies [8].

Table III. Curve fitting to the variation of total and sound length (cm), diameter (cm) and volume (cm³) with percentage of total tree height (H).

Equation	R ²	F	P-value
Knot Length			
$L_t = -0.0026H^2 + 0.2809H + 4.1313$	0.94	97.67	< 0.001
$L_s = -0.008H^2 + 0.1386H + 2.7745$	0.88	51.66	< 0.001
Knot Diameter			
$D_t = -1 \times 10^{-0.5} H^3 + 0.0013H^2 - 0.009H + 1.3014$	0.97	126.55	< 0.001
$D_s = -9 \times 10^{-6} H^3 + 0.0008H^2 + 0.0154H + 1.4951$	0.97	110.16	< 0.001
Knot Volume			
$V_t = -2 \times 10^{-5} H^4 + 0.0018H^3 + 0.0318H^2 + 0.5652H + 4.1683$	0.90	25.57	< 0.001
$V_s = -3 \times 10^{-5} H^4 + 0.0038H^3 - 0.138H^2 + 1.8758H - 3.9705$	0.90	25.60	< 0.001

In summary, the reconstruction of the maritime pine stems based on visual scanning as made in this study allowed to obtain knowledge about stem shape and internal knot distribution as well as on their variation within the tree, that was not available before. Although not representative for the diversity of provenance and growth conditions of the species, the data given here are among the first published for *Pinus pinaster* Ait. Further studies and an increased sampling will allow the gathering of more comprehensive information to be used as a tool for optimising the industrial processing, i.e. to better select logs within the stem for different final uses and as data input for yield analysis through sawing simulation.

5. CONCLUSIONS

The use of visual scanning techniques and computer-aided reconstruction was applied for Maritime pines and 3D and 2D representations were obtained for logs and trees allowing the visual appraisal of external shape as well as of the internal knot architecture. Information on tree geometry and knot parameters could be obtained from the reconstructed logs and stems. These data, although not representative for the diversity of Maritime pine in Portugal, are among the first to be published for the species.

Acknowledgments: Financial support was given to the first author by a scholarship from Fundação para a Ciência e Tecnologia (Portugal) and by a Marie Curie Research Training Grant within the EU 4th RTD Framework programme. The work was carried out under the research programme PAMAF 8185, financed by INIA (Instituto Nacional de Investigação Agrária, Portugal). Thanks are due to the Portuguese National Forest Service (Direcção Regional Agrária da Beira Litoral) who supplied the trees and their silvicultural records.

REFERENCES

- [1] Björklund L., The interior knot structure of *Pinus sylvestris* stems, Scand. J. For. Res. 12 (1997) 403–412.
- [2] Björklund L., Petersson H., Predicting knot diameter of *Pinus sylvestris* in Sweden, Scand. J. For. Res. 14 (1999) 376–384.
- [3] Colin F., Houllier F., Branchiness of Norway spruce in northeastern France: modelling vertical trends in maximum nodal size, Ann. Sci. For. 48 (1991) 679–693.
- [4] Colin F., Houllier F., Branchiness of Norway spruce in northeastern France: predicting the main crown characteristics from usual tree measurements, Ann. Sci. For. 49 (1992) 511–538.
- [5] Gomes S., Leiria National Forest – More than a hundred years producing quality timber, in: Proceedings of COST E10 2nd Workshop – Wood properties for industrial use. Ed. EFN, Mafra (1999) 90–91.
- [6] Grundberg S., An X-ray LogScanner - a tool for control of the sawmill process. Division of Wood Technology, Luleå University of Technology, Doctoral thesis, Skellefteå, 1999, 29 p.
- [7] Houllier F., Leban J.-M., Colin F., Linking growth modelling to timber quality assessment for Norway spruce, For. Ecol. Manage. 74 (1995) 91–102.
- [8] INRA, Upgrading of Southern European pines. Final report, Project MA2B-CT91-0040, INRA Bordeaux, Arbez M. (Ed.), 1994.
- [9] INRA, Modèle de croissance et qualité pour le Pin maritime (tranche 1). Second rapport d'avancement des travaux, Colin F. (Ed.), 2000, 25 p.
- [10] Instituto Florestal, Mata nacional de Leiria, Revisão do ordenamento. Ed. DGF, Marinha Grande, 1990, 150 p.
- [11] Lemieux H., Samson M., Usenius A., Shape and distribution of knots in a sample of *Picea abies* logs, Scand. J. For. Res. 12 (1997) 50–56.
- [12] Machado J.S., Avaliação da variação das propriedades mecânicas de pinho bravo (*Pinus pinaster* Ait.) por meio de ultra-sons. Doctoral thesis. Instituto Superior de Agronomia, Universidade Técnica de Lisboa, 2000, 221 p.
- [13] Moberg L., Models of knot properties for Norway spruce and Scots pine. Doctoral thesis. Dept. of Forest Management and Products, Swed. Univ. of Agri. Sciences, Uppsala, 1999, 24 p.
- [14] Mäkinen H., Colin F., Predicting branch angle and branch diameter of Scots pine from usual tree measurements and stand structural information, Can. J. For. Res. 28 (1998) 1686–1696.
- [15] Mäkinen H., Colin F., Predicting the number, death, and self-pruning of branches in Scots pine, Can. J. For. Res. 29 (1999) 1225–1236.
- [16] Märkelä A., Vanninen P., Ikonen V., An application of process-based modelling to the development of branchiness in scots pine, Silva Fennica 3 (1989) 287–299.
- [17] Oja J., Measuring knots and resin pockets in CT-images of Norway spruce. Division of Wood Technology, University of Technology, Luleå, Licenciante thesis, Skellefteå, 1997, 6 p.
- [18] Paulo M.J., Tavares M., Policiclismo do crescimento do pinheiro bravo das dunas do litoral português, Silva Lusitana 4 (1996) 25–38.

- [19] Pietilä J., Shape of Scots pine knots close to the stem pith, *Silva Fennica* 4 (1989) 287–299.
- [20] Pinto I., Modelling of wood conversion chain for *Pinus pinaster* Ait. Masters degree thesis. Instituto Superior de Agronomia, Universidade Técnica de Lisboa, 1998, 83 p.
- [21] Reimão D., Tavares M., Carvalho A., Leitão, M., Palma A., Base-line da indústria de serração de madeiras resinosas em Portugal, in: *Actas do III Congresso Florestal Nacional, Os recursos florestais no desenvolvimento rural*, Ed. SPCF Lisboa (1994) 207–231.
- [22] Saint-André L., Modélisation tridimensionnelle des profils de largeur de cerne dans un billon d'épicéa (*Picea abies* Karst) compte tenu de la mesure de son enveloppe externe et des caractéristiques dendrométriques usuelles de l'arbre d'origine. Thèse de Doctorat de l'ÉNGREF. Publication Équipe de Recherches sur la Qualité des Bois, 1998, 215 p.
- [23] Samson M., Modelling of knots in logs, *Wood Sci. Technol.* 27 (1993) 429–437.
- [24] Song T., Tree stem construction model for “Improved spruce timber utilisation” project. VTT Building Technology internal report. Helsinki, 1998, 20 p.
- [25] Tavares M., Maritime pine wood quality in Portugal, a few reasons responsible for some of its characteristics and defects, in: *Proceedings of COST E10 2nd Workshop – Wood properties for industrial use*. Ed. EFN, Mafra (1999) 81–87.
- [26] Tavares M., Campos J., Optimisation of biometric data collecting on video images of breaked up trees, using PhotoModeler and AutoCAD software, in: *Proceedings of COST E10 3rd Workshop – Measuring of wood properties, grades and qualities in the conversion chains and global wood chain optimisation*. Ed. Usenius, VTT Espoo (2000).
- [27] Usenius A., Optimizing models for predicting value yield in sawmilling industry, in *Proceedings of Seminar/workshop on Scanning Technology and Image Processing on Wood*. Skellefteå, Sweden. University of Luleå, 1992, 11 p.
- [28] Usenius A., Optimizing the activities in the wood conversion chain from forest to the end-users, in: *Proceedings of Second workshop in “Connection between Silviculture and wood quality through modelling approaches and simulation softwares”*. Kruger National Park, Nepveu (Ed.), INRA Nancy, 1996, pp. 214–219.
- [29] Vestøl G.I., Colin F., Loubère M., Influence of progeny and initial stand density on the relationship between diameter at breast height and knot diameter of *Picea abies*, *Scand. J. For. Res.* 14 (1999) 470–480.
- [30] Vestøl G.I., Høibø O.A., Internal distribution of sound and dead knots in *Picea abies* (L.) Karst, *Holz als Roh- und Werkstoff* 58 (2000) 107–114.
- [31] Zhang S.Y., Wood quality: its definition, impact and implications for value-added timber management and end-uses. CTIA/IUFRO International wood quality workshop - Timber management toward wood quality and end-product value. Quebec city, 1997, pp. 117–139.