

Helsinki University of Technology, Laboratory of Paper Technology
Reports, Series A24

Espoo 2005

**NEW BUSINESS OPPORTUNITIES FOR PRINTED MEDIA:
COATED PAPER FOR COLDSET PRINTING**

Elina Kalela

Dissertation for the degree of Doctor of Science in Technology to be presented with due permission of the Department of Forest Products Technology, for public examination and debate in Auditorium E (Main building) at Helsinki University of Technology (Espoo, Finland) on the 25th of November, 2005, at 12.

Helsinki University of Technology
Department of Forest Products Technology
Laboratory of Paper Technology

Teknillinen Korkeakoulu
Puunjalostustekniikan osasto
Paperitekniikan laboratorio

Distribution:
Helsinki University of Technology
Department of Forest Products Technology

Laboratory of Paper Technology
P.O. Box 6300
FIN-02015 HUT

ISBN 951-22-7899-5
ISBN 951-22-7900-2 (electr.)
ISSN 1237-6248

Layout: Annina Ruotsalainen
Paper: 80 gsm UPM DIGI Laser+

Picaset Oy
Helsinki 2005

Helsinki University of Technology, Laboratory of Paper Technology
P.O. BOX 1000, FIN-02015 HUT, <http://www.hut.fi>

Title: New business opportunities for printed media: Coated papers for coldset printing

Author: Elina Kalela Supervisor: Professor Hannu Paulapuro

Opponents: Dr Antti Arjas, Dr Marjatta Kleen

ISBN 951-22-7899-5, ISBN 951-22-7900-2 (electr.), ISSN 1237-6248

Keywords: coldset web offset printing, coated paper, product differentiation, product integrity, base paper, latex, paper structure, build-up

ABSTRACT

The target of this study was to identify the most important variables affecting the internal product integrity in the case of coated grades for coldset web offset printing. Internal product integrity was experimentally identified to mean in this work printing runnability and visual print quality. Printing runnability was experimentally defined to mean build-up formation tendency on the surface of the common impression cylinder (CIC) at satellite type coldset printing machines. Visual print quality was defined to mean set-off, print-through, contrast, dot-gain, evenness of printed surface and reproducibility of colors.

The objectives of this study had significant commercial value and therefore the entire experimental part was carried out on industrial scale. This experimental set-up was aiming to speed-up the application of potential findings to industrial scale and to facilitate the exploitation of the results since the time consuming and risky step of scaling the laboratory results to industrial scale could be skipped over. The experimental part of this work consists of four parts: Pilot coating of industrial base papers, printing tests in commercial coldset printing process, comparison of print quality potential of different printing methods (coldset, waterless coldset and heatset) and laboratory analyses of base paper, unprinted and printed coldset samples. Laboratory analyses included structural tests, absorption tests, various microscopic methods, permeability tests, confocal Raman analyses and various printability tests.

The results of the print quality testing showed that matt LWC printed in coldset reaches such a qualitative level that it allows the printer to exceed the technical obstacles by which the new business models are often confronted. It was further identified that coating pigments and base paper properties have influence on internal product integrity of matt LWC paper in coldset printing. The influence of coating pigments as a single variable in the fine tuning of the internal product integrity was smaller than expected. The influence of coating pigments on the internal product integrity is most likely depending on the base paper properties. A natural area for future studies would be to identify the most important paper technological variables influencing the internal product integrity via base paper properties. Latex properties as single variables did not have clear influence on internal product integrity. Latex coverage had some influence to the internal product integrity. Therefore, experimental designs profiting latex properties as multivariable parameters could bring new knowledge to the fine tuning of the internal product integrity.

Printing paper manufacturers should shift the technical testing of product prototypes to industrial scale from laboratory scale. Creation of a new product in printing paper industry should approach the standard concurrent engineering processes, where new product is widely tested in industrial scale after the innovation phase, but before market launch.

PREFACE

Interest for continuous learning and my curious character were the drivers for me to start this thesis project. Meeting the right people at right places at right moments along my professional path have made it possible to carry out this work. Without unconditional support and personal commitment of my husband I would not have finished this book.

Firstly, I would like to address my warmest thanks to UPM for financing of this work. I would like to thank you Mr Jaakko Sarantola, who's encouragement and inspiring character was particularly important at the early phase of this work. I would like to thank you as well Mr Philippe Gaudron, Mr Timo Heinonen and Mr Arto Lampinen who have, as my superiors, given me their support. I would like to thank you Mr Markku Tynkkynen for giving me the possibility to bring this work to an end.

I thank you as well my supervisor, Professor Hannu Paulapuro, for his guidance during this work and my instructor Dr Eeva Jernström for her support and instructions during this work. Special thanks to industrial counsellor Kimmo Kalela for his insights and inspiring comments.

I owe the most to my supportive and inspiring colleagues. Thank you Dr Matti Ristolainen, Dr Ainomaija Haarla and Mr Purontaus for all the efforts you have made in guiding me during this work. Warmest thanks to my colleagues at UPM Stracel Paper mill and to the UPM Matt development team.

Many thanks to Mrs Annina Ruotsalainen for lay-out and graphic edition of this work and to Mr Barry Madden for the linguistic revision.

Many thanks as well to my parents and my parents-in-law. They have always given their unconditional support to me and made it possible to successfully carry out and finish this work. I would like to dedicate this book to my husband Petteri and my children, Antti, Akseli and Ella.

Ottrott, 25.7.2005

Elina Kalela

TABLE OF CONTENTS

1.	Introduction	9
1.1	Product integrity and product differentiation process in printing papers	10
1.2	Definition of internal product integrity of matt LWC in coldset printing	12
1.3	Previous studies of coated grades in coldset printing	14
1.3.1	Literature review of ink film transfer phenomena	14
1.3.2	Role of base paper in printed paper attributes; review of earlier studies	15
1.4	Objectives	16
1.5	Approach of the study	16
1.5.1	Scope of research	17
2.	Experimental	17
2.1	Pilot Coating equipment	18
2.1.1	Coating materials	19
2.2	Printing test	19
2.3	Laboratory scale analyses	21
2.3.1	Base paper characterization	21
2.3.2	Characterization of coated, unprinted samples	21
2.3.3	Characterization of printed samples	22
2.3.4	Ink setting analyses	22
2.3.5	Characterization of printing machine deposit	24
3.	Separation of coldset ink components on matt LWC	24
3.1	Discussion	27
3.2	Summary	28
4.	Effect of coating pigments on internal product integrity	28
4.1	Influence of pigment mixture on printed paper attributes	28
4.2	Influence of coating pigment mixture on runnability	30
4.3	Discussion	32
4.4	Summary	34
5.	Effect of coating lateces on internal product integrity	35
5.1	Discussion	36
5.2	Summary	36
6.	Effect of base paper on internal product integrity	37
6.1	Discussion	40
6.2	Summary	41
7.	Correlation of laboratory scale testing to product integrity attributes	41
7.1	Discussion	43
7.2	Summary	43
8.	Evaluation of print quality potential of coldset market	44
8.1	Discussion	47
9.	Concluding remarks	47
	APPENDICES	57

LIST OF ABBREVIATIONS

CIC	Common impression cylinder
CSWO	Coldset web offset printing
FTIR	Fourier transformation infrared spectroscopy
GC	Gas chromatography
GPC	Gel permeation chromatography
HSWO	Heatset web offset printing
LWC	Light weight coated paper grade
matt	Matt, dull paper surface, Hunter gloss below 20
MFC	Light weight coated matt paper (Hunter gloss < 30) for heatset printing (in this study)
MFFT	Minimum film forming temperature
MFS	Machine finished speciality, uncoated
SEM	Scanning electron microscope
SEM-BSE	Scanning electron microscope with backscatter electron mode
THF	tetrahydrofurane

LIST OF PUBLICATIONS

- I Kalela, E., Assessment of technical tools for product development of matt LWC grades for CSWO printing, PAPTAC 91st annual conference proceedings, February 7.-10.2005, Montreal, Canada, p. D619-D624
- II Kalela, E., Desjumeaux, D., The influence of coating binders and base paper to product integrity in the case of matt LWC for coldset printing, PITA coating conference, March 15.-16.2005, Bradford, UK, p. 123-131
- III Kalela, E., Can better printing surface enhance the CSWO printing industry to adapt to the change in its business environment, PulPaper 2004 coating conference, June 1-3, 2004, Helsinki, Finland, p. 23-31
- IV Kalela, E., How to produce different surface structures for Matt LWC paper grade for CSWO printing with existing on-line equipment, Paper technology, 44(5), June 2003, p.49-56
- V Kalela, E., Ridgway, C.J., Gane, P.A.C., Ink-coating adhesion: Factors affecting deposits on the CIC satellite type CSWO press when using VAC papers, Journal of graphic technology, 1(2003):1, p. 49-58

THE AUTHOR'S CONTRIBUTIONS

In the above publications the author completed following:

- I, II, III All experimental work, analyzing of the results and writing of the original article
- IV All experimental work, except for carrying out the Raman analyses, analyzing of the results and writing of the original article
- V Designing the experimental plan, all experimental work for ISIT, ink setting, ink and printability analyses, analyzing all the results and writing the final article, except for the chapters mercury porosimetry, absorption and permeability results.

1 INTRODUCTION

The future of printed media has been on stake since the 1970's. Ever since new emerging technologies of the electronic media are threatening paper as a basis for media. Newspapers are suffering from internet expansion; they are continuously losing classified advertisement to the internet. At the same time socio-geological changes in European societies are creating major changes in our reading habits. European newspaper readers are growing older, are spending less time in reading and represent a decreasing percentage of the whole population. These reasons are partly explaining the idle press time, which is eating up the profit margins of the newspaper publisher's business. Europe's newsprint industry is facing major challenges in its transition to the 21st century./1-3/

The major challenge for an average newspaper publisher is how to expand beyond the existing core business of newspaper publishing. Traditional business models propose that development is possible in one or more of four ways /2/:

- Through a shift in the life cycle of an established product, either through product enhancement, or increased market activity
- By taking existing products into new markets
- By launching new products into existing markets
- Through diversification in both markets and products

Innovation in redesigning the newspaper concept and increased sensitivity to reader's needs are essential in order to create new business models which can reshape the lifecycle of newspapers. New business models can, as well, be developed by shifting products at the growth phase of their life cycle to newspaper publishers' coldset printing machines from other printing methods like heatset printing. This requires innovations to overcome technical barriers, which are often related to the print quality of the coldset printing process. Magazine-like inserts and free commuter newspapers are examples of new products and new markets.

A coated paper grade for coldset printing is the potential answer from a paper producer. It can open new possibilities for product enhancement and thereby for new business models. It is the outcome of a customer driven product differentiation process of a printing paper manufacturer. The practical consequences of the product differentiation process to a paper producer are numerous. The differentiation process consists of several sub-processes which have different targets, are running in different time scales and are performed by various persons. Activities during the differentiation process occur, at least, in the following three (3) main categories:

1. Business concept development
2. Strategy work (marketing, sales, service, logistic, etc.)
3. Paper making activities; product development, production optimization, technology development, etc.

In connection with the commercial launch of a coated grade for coldset printing, some difficulties were discovered. These problems included technical problems related to conventional paper making, behaviour of coated paper in coldset printing process and lack of existing tools and processes for the needs of such a large product differentiation move.

1.1 Product integrity and product differentiation process in printing papers

According to earlier studies, product differentiation in the printing paper industry is a complex issue and can take many forms. Haarla /4/ states in her recent work that certain characteristics can be found, but does not give an exact definition to product differentiation. Haarla /4/ shows that product differentiation in the future is becoming increasingly an advertiser or customer pulled process. More tools are needed to understand the connection between the perception of the customer and the needs of the manufacturer in order to create a successful differentiation process that adds value to both the customer and the manufacturer. Recent studies /5/ show the problems related to this connection. Jernström /5/ gives in her work principle guidelines to a paper manufacturer how to produce qualitative conclusions from publisher's expectations related to the perception of the product. According to Jernström's studies /5/ the product integrity concept is a good tool when studying the customer value creation from product oriented view. Jenström defines External and Internal product integrity as follows:

- External product integrity means that the customer expects the product to harmonize with his lifestyles and values. Therefore the external product integrity is related to the customer's (publishers or printers) intended goals and objectives related to lifestyle and values of the targeted consumers.
- Internal product integrity is the ability of the product to fulfil customers' expectations of the functionality of the product.

Figure 1 combines findings of Haarla /4/ and Jernström /5/. It shows the connection between the product differentiation process of a magazine publisher and a paper manufacturer. As a result of the publisher's differentiation process the external product integrity is defined. In the next step internal product integrity is identified by certain customer specific definitions and descriptions. As figure 1 shows, between the publisher's product differentiation process and the paper manufacturer's product differentiation process we can find a grey zone, the customer interface, where customer's internal expectations (internal product integrity) are defined and translated to printed paper attributes and expectations in the end-use situation /5/.

The work, creating internal product integrity from external integrity is usually considered very difficult, since it involves translation of abstract concepts, feelings and images to concrete printed paper attributes and printing runnability. It is not possible to do this work efficiently and successfully without involving an expert network. People working in different parts of a paper manufacturer's organization together with people from outside companies (customers, advertisers, etc.) have to put their knowledge together. This often creates an additional management and leadership challenge for the classical organization models of paper manufacturing companies. On the other hand we are lacking tools. The development of sensory based analyses, which are often irreplaceable when converting external product integrity requirements to internal product requirements has started only recently /6/. These reasons could partly explain why traditionally, in the case of printing papers, the bond between external product integrity and the differentiation process of a printing paper company is weak /4/.

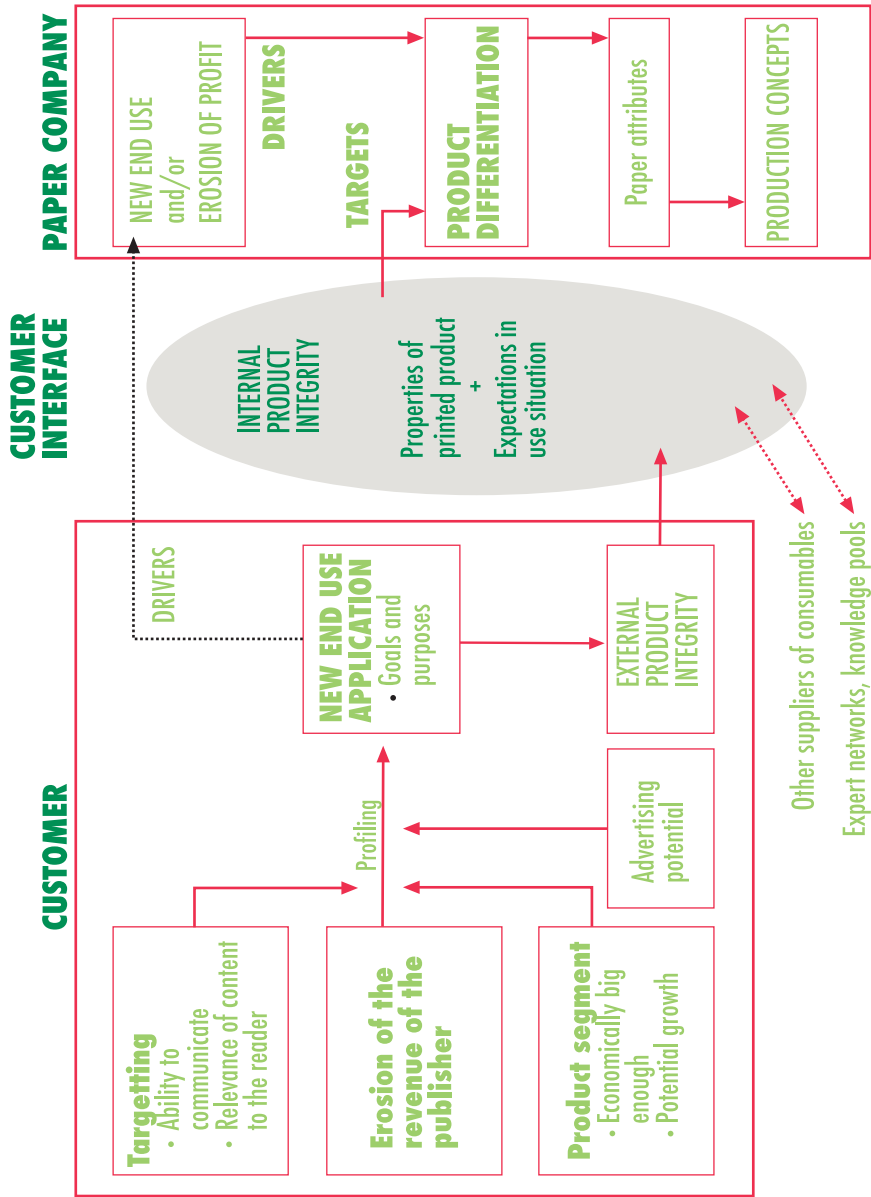

Figure 1. The link between product differentiation process of printing industry and printing paper company, definitions of external and internal product integrity concepts. /4,5/

The defining of printed paper attributes and runnability requirements of printing are only the beginning of the long product differentiation process for a paper company. Definition of the printed paper attributes and runnability give the first concrete targets for the future product. The paper manufacturer uses these targets as a baseline in order to define the most important paper attributes of the future product. Based on this they create the most economical production concept. In order to reduce the cost and speed-up the creation of a new product, paper manufacturers have developed laboratory scale tests for prediction of runnability and printed paper attributes. Earlier studies report varying correlation between laboratory scale tests and printed paper attributes. There is always a scaling problem related to translation of laboratory scale results into industrial scale production. /7-19/

1.2 Definition of internal product integrity of matt LWC in coldset printing

The definition of product integrity was developed by carrying out discussions with representatives of selected customers. These discussions were not fully standardized and were usually partly carry out in form of a discussion. The interviews were done on several occasions and during the years. This type of working method was typical for this customer driven product differentiation process.

The semi-structured interviews consisted of three basic questions that were asked every time the customer was met. In addition clarifying questions were improvised during the discussion. These small questions were not repeated and they varied from one customer discussion to another. Basic questions asked during the discussion were:

- For which printed products do you use matt, light weight-coated (LWC) grades (film coated)
- Describe what are the specific characteristics in the matt LWC grade that enable you to use it for new and innovative printed products
- What are the most important factors, from your point of view, when creating new printed products using matt LWC

An important part for the product integrity analyses were the measurements of optical print quality of the printed material, which was always collected during the interviews.

The result of the internal product integrity definition process is presented in Figure 2. Internal product integrity was further translated to measurable printed paper attributes and printing runnability requirements were also defined.

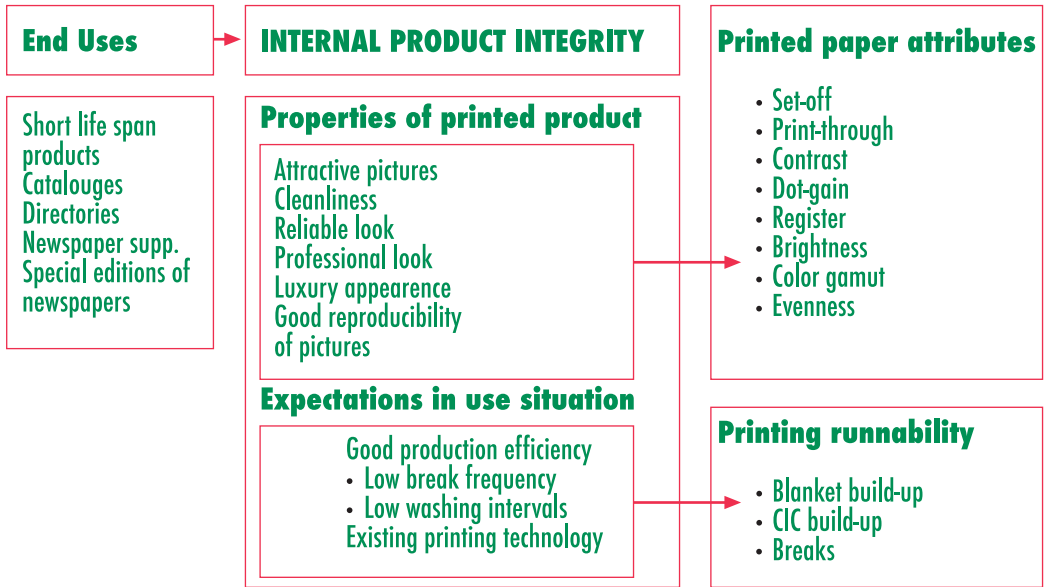

Figure 2. New end uses, related internal product integrity, properties of printed product and printing runnability of matt LWC in coldset printing

It was found that the runnability requirements were slightly different for steel-to-blanket type printing machines, also called satellite presses, than for blanket-to-blanket type printing machine, as well called tower presses. Table 1 summarizes the specific requirements of these printing machine types.

Table 1. Printed paper attributes and runnability requirements of matt LWC in tower presses and satellite

tower press	satellite press
set-off, print-through, dot-gain, contrast, color gamut, brightness evenness	set-off, print-through, dot-gain, contrast, color gamut, brightness evenness
register	
blanket build-up	common impression cylinder build-up
free of tension problems and low break frequency	tension problems and other break reasons
mailing department runnability	mailing department runnability

Feedback from customers during the interviews showed that runnability related requirements were well met in tower presses, but problems occurred in the satellite presses. The main problem was the formation of build-up in the surface of common impression cylinder (CIC). More detailed description of this problem can be found in Paper V. Print quality requirements were well met for both printing machine types.

The definition of the printed paper attributes and printing runnability requirements shown in figure 2 is relatively subjective rather than a result of a comprehensive scientific product analyses. Since no previous studies about the product integrity of coldset products were found, the methodology presented here can be proposed as a starting point for future studies in this area. As such, the results in Figure 2 give new and unpublished information about the internal product integrity of matt LWC for coldset printing.

The most important success factors in these interviews and discussion sessions were:

- Good inter-personal relations between the people involved in the product development process and the relevant people in the customer's organization
- The understanding of the roles and characters of different people in the customer's organization and thereby measuring the capability to position the comments and messages from each person in the relevant context.
- Keeping the dialog alive and continuous

The most difficult part of the product differentiation process is the translation of abstract definition of the internal product integrity to measurable printed paper attributes. The translation is related to specific end-uses and printed products. In the context of this work the main printed paper attributes were set-off, print-through, dot-gain, contrast, color gamut and evenness of the print. The main attribute of the printing runnability was the deposit formation tendency on the CIC surface.

1.3 Previous studies of coated grades in coldset printing

The coldset printing process has been used for a long time for production of newspapers. Light weight coated (LWC) paper grades have been available since the 1970's. This study is carried out with film coating technology, which has increasingly been applied in the production of coated paper grades since the early 90's. Very limited amount of information is available on the coated paper behaviour in coldset printing. Rather limited amount of information is available as well on the creation of end-products other than newspapers for the coldset printing process.

1.3.1 Literature review of ink film transfer phenomena

Film coating and ink transfer in the printing nip are both thin film transfer processes. According to Nordström /20/ film transfer can be divided to three regions according to the portion of film transferred from the original film available. More information about Nordström's theory can be found in paper II. In the first film transfer region (I) the amount of film transferred increases over time and finally reaches the maximum transfer coefficient. In this region the transferred film creates an incomplete coverage on the substrate's surface. A significant part of the transferred liquid disappears in the empty pores and holes present at the surface. Characteristic structures of involved surfaces, like shape of holes and pores and roughness profiles, dominate the film transfer. According to earlier studies /21/ ink transfer in coldset printing of uncoated paper surface belongs most likely to the first region. Film splitting occurs in those places, where ink stays in the paper surface and in continuous contact with the original ink film on the blanket. The ink film does not physically immobilize in the nip, but the pressure pulse of the printing nip forces a major volume of the transferred ink film to loose its contact with the original film on the blanket. Therefore, this portion of the film can no longer participate in film splitting at the exit of the nip. In addition to the characteristic surface structures, the ink film transfer is influenced by compressibility and elasticity of the paper and surfaces of the printing nip under pressure. The rheology of commercial

inks influence the ink transfer mainly in the inking rollers of the printing machine and only plays a minor role in ink film transfer between blanket and paper. No previous research was found about the ink film transfer mechanism on coated paper surface in coldset printing. /20-38/

The film coverage in region two (II) is typically continuous and complete, thus the film transfer is more stable. Region two film transfer conditions are reached when demands set by the film properties are fulfilled by the area/volume properties of the substrate. According to earlier studies /39/ on homogeneous, continuously covered coated surfaces, the ink film transfer in region two is determined by absorptive and volumetric properties of the coating layer. When the ink film thickness increases, the influence of the substrate diminishes. In thick film transfer the fluid properties dominate over the influence of the substrate. According to Nordström /20/ the rheological properties and fluid dynamic forces of the liquid medium alone determine the thick film transfer.

Contradictory to coldset printing, it is believed that the film transfer conditions in heatset printing are in region two (II) when coated papers are used. The ink film properties, which are largely determined by the proportion and type of oils used (up to 80%), are together with coating and/or surface structure and chemistry of the paper determining the absorptive characters and thus the ink film transfer and immobilization at the printing nip. The pressure pulse of the printing nip causes some of the low-molecular weight oils of the thin ink film to penetrate into the paper and to separate from the original ink film. This immobilizes part of the ink film, but as ink pigment particles start to block some of the capillaries and voids at the surface, part of the ink layer stays mobile and film splitting occurs at the exit of the printing nip at this mobile layer. Pressure pulse, capillary driven absorption and diffusion are the main penetration mechanisms of heatset ink oils. The physical arrangement of the pores in the coating layer, the surface chemistry of the coating layer and the properties of the latices used in the coating layer are determining the absorption kinetics. Rousu /39/ suggests that latices influence either the porous structure of coating or interact directly with oils, introducing a diffusion driven transportation mechanism on their own. Desjumaux /40/ states that the role of latices in ink oil separation is dependant on the addition level of latices in the coating. It is widely assumed in earlier studies, that LWC papers have high coating coverage and, therefore, the pore structure of the coating is equal to the area/volume properties of the paper surface. Most of these studies have been carried out in the laboratory scale using model coatings. /39-60/

According to Nordström /20/ the third film transfer region (III) characteristically features an even film split of the free layer and the percentage of the film transfer over time remains constant. In this region the thick film fluid properties dominate over the influence of the substrate. The rheological properties and fluid dynamic forces of the liquid medium alone determine the film transfer. Most likely the film transfer in many of the laboratory scale ink or oil penetration tests on model coatings is taking place in the characteristic conditions of the third film transfer region. The scaling of such results to industrial conditions creates major problems since film transfer conditions in commercial offset printing machine seldom reach the characteristic conditions of third film transfer region.

1.3.2 Role of base paper in printed paper attributes; review of earlier studies

Previous studies /61-75/ have shown that the base paper influences the coating layer formation in film coating as defined in the thin film transfer theory by Nordström /20/. Depending on the desired printed paper attributes and printing runnability different properties of base paper can be considered important. Grön found in his studies /66,68/ that base paper should not have too many large pores in order to minimize the penetration of coating color into the pores because better coating coverage improves the print result in heatset printing. A common agreement on the influence of other base paper variables on the printed paper attributes and printing runnability in

heatset printing of coated papers does not exist. No earlier studies were found about the influence of base paper variables on printed paper attributes and printing runnability for coated papers in coldset printing.

1.4 Objectives

The aim of this study was to identify the most important variables affecting the internal product integrity in the case of coated grades for coldset printing. The potential tools for technical product development of LWC grades for coldset printing were as well evaluated.

Based on earlier studies the objective was analyzed by dividing it into the following hypothesis:

1. There is such a print quality difference between matt LWC and uncoated paper grades in coldset printing that it enables newspaper publishers to overcome some of the technical barriers hindering the expansion of their business by using coated paper
2. Differences in coating structure created by coating pigments influence the internal product integrity of matt LWC paper in coldset printing
3. Changes in base paper properties influence the internal product integrity of matt LWC paper in coldset printing
4. Latex variables influence the internal product integrity
5. Fractionation of ink compounds on the surface of matt LWC paper influences the runnability in coldset printing
6. In order to get reliable results for the commercial product development of matt LWC grades for coldset printing, other test methods than laboratory scale tests has to be used

1.5 Approach of the study

This study concentrates on testing the above hypothesis. This thesis can be divided to following parts:

1. The introduction chapter sets the background for this work: a summary of the business environment of the newspaper publishing industry today, a description of the product integrity concept and a definition of the internal product integrity of matt LWC grades for coldset printing are given here. A summary of the related previous research work in the area of coldset printing and printing of coated paper grades in offset is as well presented here.
2. In the experimental part the influence of the coating pigments, latices and base paper to the internal product integrity was investigated. Six (6) different base papers were produced in two industrial production lines. Base papers were coated in pilot scale and printed in commercial coldset printing machine. Influence of different coating pigments and binder systems to the internal product integrity was investigated.
3. The suitability of various laboratory scale printability tests for product differentiation work was assessed.
4. Commercial papers were printed in industrial scale and the quality potential of today's coldset market was defined

The thesis is based on five (5) publications, which contain unpublished information about the behavior of matt LWC paper in coldset printing. Original publications can be found in papers I to V.

1.5.1 Scope of research

The following limits have been set for this study:

1. This study is valid in film coating environment only.
2. Coldset printing machines use different printing nip configurations. This study has been carried out using steel against soft blanket configuration, which is commonly known as satellite type printing machine.
3. Base paper raw materials, production technologies as well as printing consumables have been limited to commercially existing materials.
4. The influence of raw materials, production technology and papermaking variables to base paper properties has been excluded from this study
5. Coated paper in this study means matt light weight coated paper (Hunter gloss <20, coat weight < 10 g/m²/side).

Due to the fact that the objectives of this study had significant commercial value, the entire experimental part was carried out on industrial scale. This experimental set-up was estimated to speed-up the research and to facilitate the exploitation of the results since the time consuming and risky step of scaling the laboratory results to industrial scale could be skipped over.

2 EXPERIMENTAL

The six selected hypotheses were tested in the experimental part of this work. This testing consists of five parts:

- Production of base paper
- Pilot coating of industrial base papers
- Printing tests in commercial coldset conditions
- Comparison of print quality potential of different printing methods (coldset, waterless coldset and heatset) using the same commercial uncoated and coated paper grades (printing trial)
- Laboratory analyses of base paper, unprinted and printed matt LWC samples

Pilot coatings were carried out in three separate studies. Table 2 summarizes the coating variables tested in each pilot trial. Evaluation of internal product integrity, laboratory analyses and printing was carried out in the same way for all produced papers.

Table 2. Main experimental plan used in the pilot coating sequences

variable	Pilot 1	Pilot 2	Pilot 3
BASE PAPER			
Base 1, fiber mix A	x		
Base 2, fiber mix A	x		
Base 3, fiber mix A	x		
Base 4, fiber mix B	x		
Base 5, fiber mix A		x	
Base 6, fiber mix A			x
COATING COLOR			
Lateces A-F		x	
Additives		x	
Pigments A-F			x

2.1 Pilot Coating equipment

Figure 3 shows a schematic picture of a pilot coating device used in these experiments. Coating trials were carried out at Metso Järvenpää, Dow Horgen and Imerys Lixhe pilot plants. The equipment, conditions and targets were similar in all three pilot trail sessions.

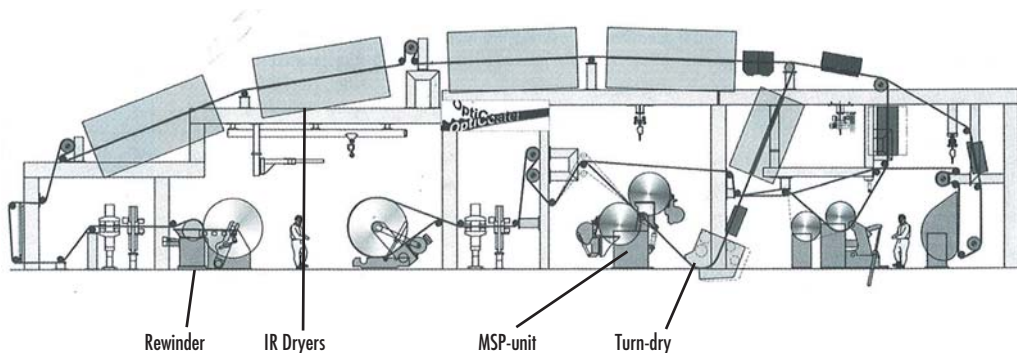

Figure 3. Optimizer pilot coater at Metso Järvenpää.

The coating color was premetered onto the roll surface with a smooth rod. The target coat weight was 6 g/m² per side. In order to reach the target coat weight rod diameters were different depending on the base paper and coating color formulation. Both sides of the base paper were coated simultaneously.

The nip pressure between the pivoted roll and a bottom roll was 20 kN/m and the hardness of the polyurethane rolls was 35 P&J. The machine speed during trials was 1500 m/min. After the MSP unit the web was dried with air flotation dryers and an IR dryer as shown in Figure 3. The target moisture content of coated paper was 6.5 %. No preheating was used at the coater. Coated papers were calendered with a pilot calender using one soft nip to a constant roughness target.

All pilot coating sessions were targeting to produce paper as close as possible to the industrial scale. More details about the production parameters of the coated mill paper can be found in paper IV.

2.1.1 Coating materials

The first coating study investigated the role of base paper. Four different base papers were each coated with constant coating color recipe (CC1 and CC2). A more detailed description of the first trial can be found in paper II. A second coating trial studied the influence of latex binders. Table 3 summarizes some of the characteristics of latices used in this experiment. Coating pigments were used as the variable in the third coating sequence. Table 4 shows the main characteristics of the pigments tested in 3rd trial. More detailed description of this trial can be found in paper III.

Table 3. Characteristics of latices used in second coating trial

Latex	Tg/MFFT [°C]	particle size [µm]
A	20/18	0.14
B	21/20	0.13
C	0/-1	0.19
D	20/18	0.14
E	<0/<0	-
F	17/15	0.14

Table 4. Characteristic features of pigments used in 3rd trial and the exact mixtures used in coating recipes

Pigment	Particles <2 µm [w-%]	Trial point	Mixture
A	97	1	100 % ref
B	16	2	75% ref./25% A
C	46	3	75% ref./25% B
D	46	4	25% D/75% C
E	30	5	40% E/60% F
F	98	6	20% A/40% E/40%F
Ref.	65		

2.2 Printing tests

Several printing tests were carried out for the papers produced in the coating trials. A commercial WIFAG OF 790 stacked satellite type coldset press was selected for the testing. According to IFRA roughly 40% of the presses sold in Europe during last three years were satellite type presses. Therefore a wifag OF 790 was estimated to represent well the present press technology used at european coldset printing market. The test run included standard operations in mailing department.

The press configuration is shown in Figure 4. The first satellite unit consists of nine cylinders and the second satellite unit is a ten-cylinder satellite. The distance between the satellite units was 6.5 m and the speed of the press 7.8 m/s. Standard mailing department operations included transportation of individual copies and making of newspaper bundles.

Four colors were used at the first satellite unit. Black and cyan were used at the second satellite unit. The concentration of the fountain additive in the solution was 3%. Conductivity and pH of the fountain solution were monitored and kept constant during the test (pH 5 and conductivity 1230 $\mu\text{S}/\text{cm}$). All consumables were standard commercial coldset process materials.

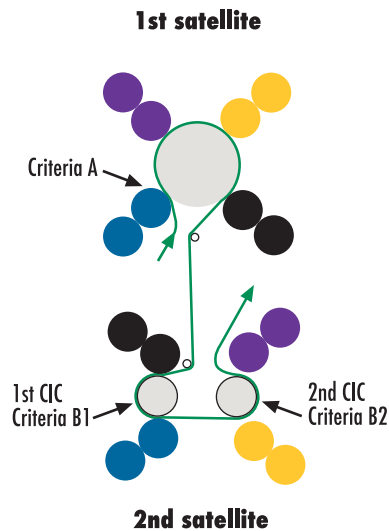

Figure 4. Press configuration used at commercial printing tests

The rate of deposit build-up on the 1st common impression cylinder (CIC) of the 2nd satellite was evaluated (criteria B1 on Figure 4). As well the build-up rate on blankets (criteria A) and general mailroom performance were monitored. Each trial point consisted of approximately 30 000 cylinder revolutions. At the end of each trial point the printing machine was stopped and the common impression cylinders were inspected and digitally imaged. The build-up rate was assessed visually from the digital pictures. Results were expressed as build-up index in scale 1-9, where build-up index 9 was given to the lowest build-up rate (“best performance”) and 1 to the highest build-up rate. An example of the digital images can be found in paper V. Two types of build-up, corresponding to the runnability of the paper were identified: Positive and negative. They were defined as follows:

- Negative build-up can be found on the non-image areas of the first printed side of the web as seen against the first CIC of the second satellite unit (Criteria B1 in figure 4). The delay between the first and second satellite units is typically around 1 second or slightly less. The deposit is being observed just after the first colour on the verso side of the paper web has been printed down. When negative build-up is formed, no trapping of the deposit is seen back onto the non-image areas of printed, final product.
- Positive build-up is formed on the first CIC surface of the second satellite unit (criteria B1 in figure 4) in places where image areas of the first printed side of the web are in contact with the cylinder surface

Paper III gives more detailed information about the heatset and waterless coldset printing trial procedures.

2.3 Laboratory scale analyses

2.3.1 Base paper characterization

Base paper and coated paper measurements included standard absorption, structural and optical tests. Detailed description about the used methods can be found in appendix 6.

2.3.2 Characterization of coated, unprinted samples

All measurements done on base paper were also performed on the coated, unprinted samples. In addition, analyses characterizing the coating and pore structure were done. Detailed description about the used test methods can be found in appendix 6.

The coating coverage was measured using the scanning electron microscope-back scatter electron (SEM-BSE) method, where scanning electron microscope images are analyzed in the back scatter mode. In this method the differences of the atomic weights of the elements present in the sample give different grey values in the picture. Coating coverage is presented as a percentage value. Higher value means bigger area covered by the pigments.

Confocal Raman measurements were done in order to analyse the depth profiles and x-y surface maps of the latex concentration in the coating layer. The depth of one step in the vertical direction (i.e. z-direction) was 1 μm while the total depth of the measurement was 40 μm . Two parallel samples were chosen from each test point and 6 parallel depth profiles were measured from each test point. Raman maps in the x-y-plane were measured from two points in order to study the pigment and binder distribution on the coating surface. Size of the measurement area was 3.9 mm x 3.9 mm. A detailed description of the Raman analyses can be found in Paper IV. /76- 78/

Porestructure, absorption and permeability of the samples were studied using three independent methods developed by Gane, Ridgway, Kettle, Matthews, Spielmann and Schoelkopf /79-85/. These three methods are described in detail in Paper V.

The rate of fluid uptake into paper sheets (measured in the machine direction) was determined using an automated microbalance (Figure 5), following the methodology of Gane, Schoelkopf *et al.* /81,82/.

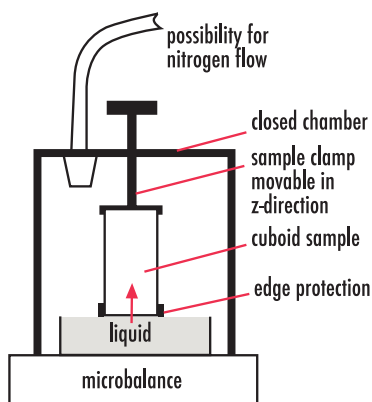

Figure 5. Gravimetric wetting apparatus /81/

The permeability of papers was studied using liquid permeation under pressure through a saturated sample, using a methodology designed by Schoelkopf *et al.* /83,84,85/ for macroscopic pigment tablets. It was necessary to develop the methodology further for determining the permeability of the paper samples to liquid in the cross-section (z) direction, whereby a stack of laminar sheet samples are mounted surrounded by resin as shown in Figure 6. More detailed description of this test can be found in Paper V.

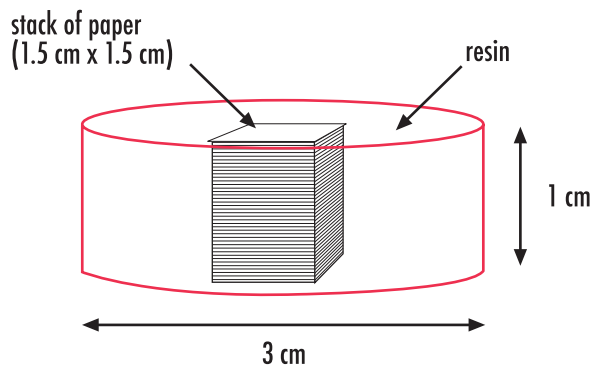

Figure 6. Preparation of paper stack for permeability measurement./84/

2.3.3 Characterization of printed samples

A trained group of people in UPM Research center performed a visual evaluation of the printed samples. Set-off, print-through, dot-gain and contrast were measured from specific areas of the test form (paper III). Set-off was measured using the Y-value of Elrepho 2000-device (ISO 2471). Print-through was measured in the same way as K&N ink absorption value using Elrepho 2000-device. Dot-gain (50% coverage, black) and contrast (75% coverage, black) was measured with a densitometer from the test form.

Raman technique was used in the determination of ink layer thickness on the surface of the printed paper sample. The method is described in detail in Paper IV. Thickness of ink layer was measured using light microscopy, as described in Appendix 6.

2.3.4 Ink setting analyses

Prüfbau printing was carried out according to Särelä's principles /21/. Prüfbau set-off was measured at 1.0, 2.5, 10 and 60 s delays. Table 5 summarizes the test conditions for the Prüfbau printing. The results were interpolated and presented at constant density (1.3) and at constant ink amount (1.5 g/m²). Density was measured using Gretac D 19 C densitometer. Delta set-off was defined as the ratio of difference in set-off density at 1.0 s and 60 s to the initial set-off (at 1.0 s). Set-off and print-through were measured using Y-value of Elrepho 2000 device and the result was given in percentage value as described in the K&N ink absorption test (Appendix 6).

Table 5. Printing conditions at Prüfbau laboratory test

variable	setting
ink	Bucher, Zeitungs Schwarz
set-off delays	1, 2.5, 10 and 60 s
pressure, nip 1	15 kN/m (600N)
pressure, nip 2 (set-off)	15 kN/m (300 N)
set-off paper	same as test paper
sample carrier	blue rubber
printing disc 1 / disc 2	rubber / metal
ink distribution / disc inking time	30 s / 15 s
ink additions	10 / 50 / 50 mm ³
printing speed	1 m/s

The basic physics behind the tack force measurement (ISIT) has been described previously /86/ and a typical tack curve and test strip after testing are illustrated in Figure 7. The interpretation proposes a rupture at the weakest point of the adhesion/cohesion chain, either between ink and paper or between ink and blanket, or within the cohesive layer of the ink itself. More information about the ISIT testing can be found in paper V.

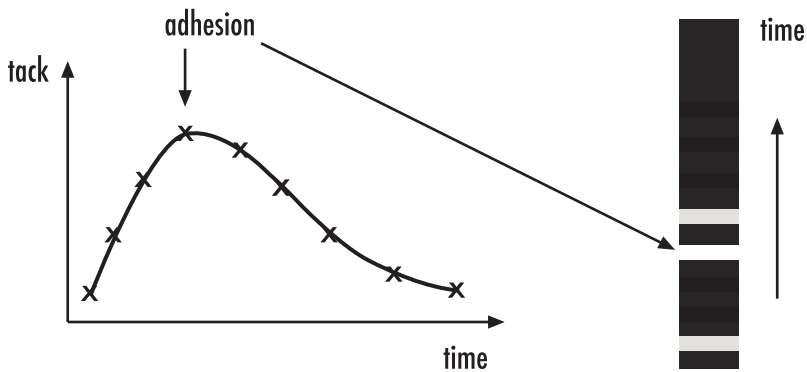

Figure 7. Schematic of a typical tack cycle curve and test strip showing the residual print density after “pull-off”.

Penetration and separation of ink components (resin and oils) on the coated paper surface was studied with a chromatographic method developed by Mattila *et al.* /41/. Two commercial paper samples and two commercial coldset inks were tested. The samples were first printed on a laboratory scale to a constant ink amount using the IGT AIC2-5 device. Printed samples were progressively ground from the top surface with the surface grinding machine shown in Figure 8, removing layers with known thickness as determined by measuring the paper thickness before and after grinding. The ground samples were then extracted with tetrahydrofurane (THF) and analyzed by gas and gel permeation chromatography to reveal the amount of ink components left in the paper. To be able to examine the penetration behavior of ink resin itself, unprinted paper samples were also ground and the amount of binders present in the paper itself were subtracted from the total signal intensities. Three parallel printing, grinding and analysis series were produced from all samples.

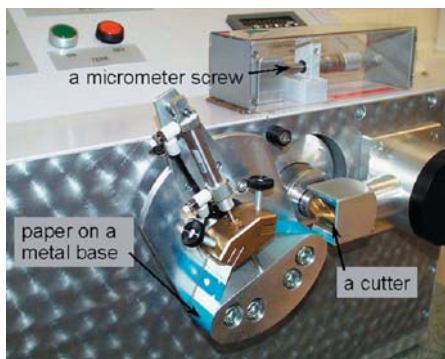

Figure 8. Surface grinding machine for sample preparation for GPC and CG analyses of ink components /41/

The ink samples were labelled P and U. The P ink had a low build-up rate in printing tests and the U ink had a clearly higher build-up rate. The two matt LWC samples were labelled A and B. They had also different performance characteristics in the printing test: sample A is a high build-up rate paper and sample B a low build-up rate paper.

2.3.5 Characterization of printing machine deposits

Build-up samples collected from the CIC surface of the second satellite (criteria B) were qualitatively analyzed. Analytical pyrolysis technique was used for the determination of the latex content of the sample. Inorganic compounds were identified using SEM/EDS technique. FTIR technique was used for the identification of ink compounds from the build-up samples.

3 SEPARATION OF COLDSET INK COMPONENTS ON MATT LWC

The results of the Raman spectroscopic analyses show that ink pigments can be found inside the coating layer when looking at commercial coldset samples of matt LWC paper. Figure 9 shows the respective location of coating layer and magenta ink pigments.

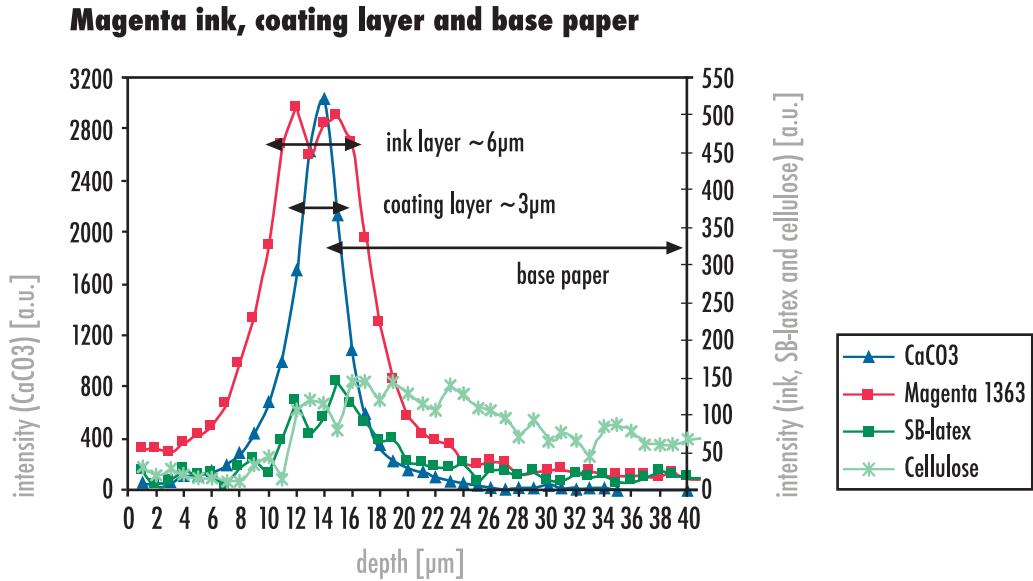

Figure 9. A depth profile of printed matt LWC by Raman spectroscopy. The distribution of magenta ink, coating color components and cellulose is shown by step response curve

The results of the penetration study show that ink and paper both play a role in separation of the ink components. Differences in surface characteristics between papers A and B result in different ink film transfer. As figure 10 shows, this further results in different relative resin amounts on the two papers when moving inside the paper while using ink P. On the other hand this behaviour can not be seen when using ink U. Ink U behaves in the same way on both papers A and B, while ink P is more sensitive to characteristic surface structure of paper and shows a different result for paper A and B. When using paper as constant, it can be seen that inks P and U give different results when applied on paper B. This difference between inks P and U can not be seen when printed on paper A. These results indicate that it can not be said that exclusively ink or paper determine the penetration rate of resin compound of the coldset ink on coated surface, when using IGT printing technique.

Relative resin amount as function of paper depth

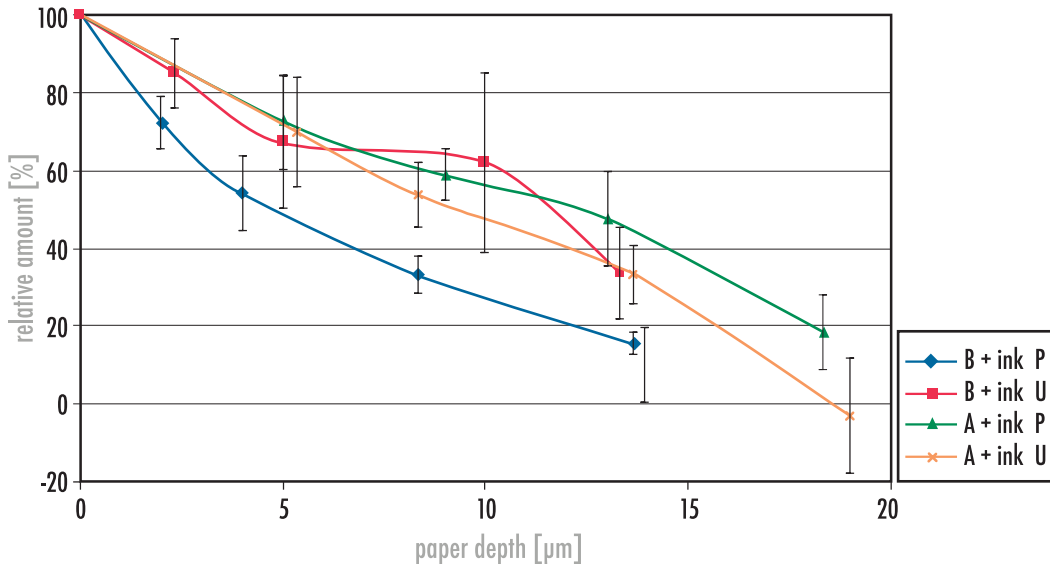

Figure 10. Relative resin amount as function of paper depth (75% error margin)

The separation of resin component from mineral oil component was generally not very significant in this experiment. Only ink P shows some degree of separation on both papers A and B as can be seen from Figure 11. Separation seems to occur closer to the surface on paper B than on paper A. The curves shown in Figure 11 are calculated relative to the original value, which is given value 1. This means, that a change of separation degree from 1 to 2 indicates that the concentration of the oil component related to the resin component has doubled. The error in separation degree is quite large due to several steps in calculation.

Separation of ink oils from resin

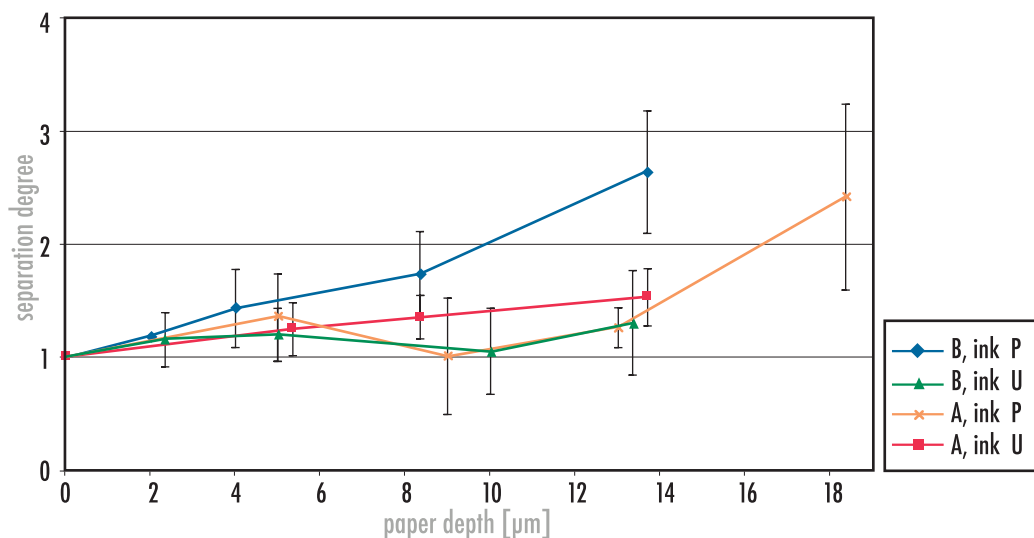

Figure 11. Separation degree of oils from resin as function of paper depth. (75% error margins)

Separation behavior of vegetable oil was similar to mineral oil. Inks P and U had a similar low concentration of vegetable oil. Ink U had a higher concentration of mineral oil, as summarized in table 6.

Table 6. Mineral oil and vegetable oil concentrations in ink samples P and U

component	sample P	sample U
mineral oil [mg/l]	1.8	3.3
vegetable oil [mg/l]	0.1	0.1

3.1 Discussion

The oils of commercial coldset inks can separate from resins on the matt LWC surface as proposed in earlier studies /21/ for uncoated surfaces. Contrary to earlier studies /21/ for uncoated surfaces, low molecular weight vegetable oils did not show different separation behavior compared to higher molecular weight mineral oils. Earlier studies /21/ propose that on uncoated surfaces some separation always occurs. In this study the separation is not always taking place independently from the paper used. Commercial ink U did not show any separation of oil from resin.

The results showed as well that oils and resin do penetrate into the interior of paper. The mechanism for this penetration was not investigated, but it is most likely not only capillary driven, since high molecular weight oils were also found in the interior of paper. The penetration of higher viscosity, high molecular weight oils by capillary absorption up to 20 μm is not as likely as it would be for lower viscosity, lower molecular weight vegetable oils. Based on the kinetics it should be likely that lower molecular weight oils could penetrate deeper into the paper by capillary absorption than higher molecular weight oils. Based on this assumption it could be stated that other forces than capillary penetration play as well a role in this penetration. Pressure pulse could be the dominant force acting in the penetration of oils and resins into the paper.

In this experiment the paper seems to have an influence on the separation depth of oil and resin. This could be an indication that the film transfer conditions in this penetration test are in region I or II, since fluid properties alone do not determine the separation depth and thus film transfer.

It has to be mentioned that the separation measurements were performed 24 hours after printing. Since it is not known if the separation phenomenon is linear or not as a function of time, it is possible that the degree of separation is much smaller or similar immediately after printing.

The influence of higher radial and circumferential forces in industrial scale printing when compared to laboratory scale IGT printing used in this test is difficult to estimate. It is impossible to do absolute scaling of the results and the proposed separation mechanisms to an industrial scale. It can be generally proposed that increased applied forces could potentially increase the separation depth and as well increase the total penetration of both resins and oil into the paper web. Raman analyses support this assumption, since they show that magenta ink pigments can be identified inside the coating layer. These pigment particles could have been pushed inside the coating pore network by a pressure pulse.

The combination of paper B+ink P gives, in commercial printing, the smallest rate of CIC build-up. The results of this trial point differed the most from the other test points of the penetration study. For the best sample all the examined ink components (mineral and vegetable oil, resin) were kept closest to the surface layers. The separation of oils from resin took place closest to the surface during the first 15% of the whole thickness of the sample. The separation degree was the highest, while the total oil volume was low. It could be concluded that a high degree of separation of oils from resin and penetration of small volume of both components into the paper decrease the CIC build-up tendency of matt LWC paper.

3.2 Summary

Contrary to earlier studies of the separation behaviour of oils and resins of coldset inks on uncoated surfaces, it was found, that at least one commercial ink does not show any separation behaviour on a coated surface. Such inks are likely to decrease print quality and contribute to printing runnability problems. It could be suggested that the best results on runnability of matt LWC can be reached with such inks that show a high degree of separation and that retain both oils and resin at the upper surface layers (15 % of the whole thickness) of the paper.

4 EFFECT OF COATING PIGMENTS ON INTERNAL PRODUCT INTEGRITY

The pore structure of matt LWC was modified with coating pigments on the 3rd trial. As Table 7 shows the selection of coating pigment mixture has an influence on the pore structure of the matt LWC paper grade.

Table 7. Results of mercury porosimetric analyses of the coated paper samples of 3rd coating trial.

Trial point	Pore volume [cm³/kg]	Average pore size [µm]	Number of pores [pores/µm²]
1	89	0.39	16.3
2	64	0.16	81.8
3	89	0.30	28.1
4	76	0.20	57.1
5	68	0.10	212
6	78	0.11	192

4.1 Influence of pigment mixture on printed paper attributes

The total pore volume has an influence on the printed paper attributes of matt LWC. As Figure 12 shows pore volume has a significant influence on contrast. Increasing the total pore volume decreases the contrast and increases dot-gain.

Contrast as a function of pore volume

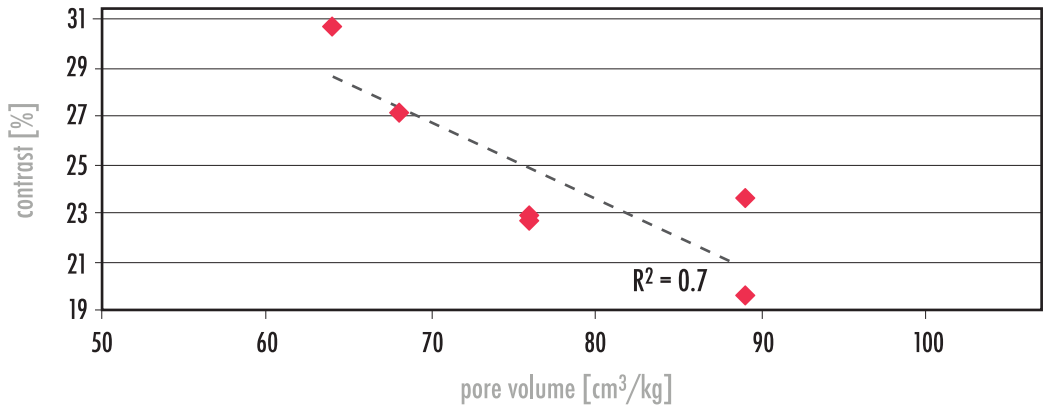

Figure 12. Contrast (black) as function of total pore volume

Dot-gain is influenced by pore size as figure 13 illustrates. Dot-gain increases as pore size increases.

Dot-gain as a function of pore size

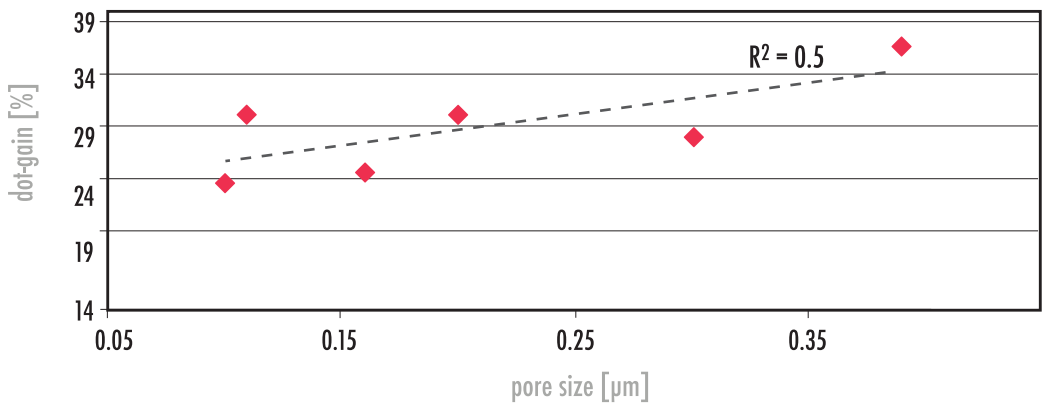

Figure 13. Dot-gain as function of average pore size

The print density has a tendency to increase with increasing pore size as figure 14 illustrates.

Density as a function of pore size

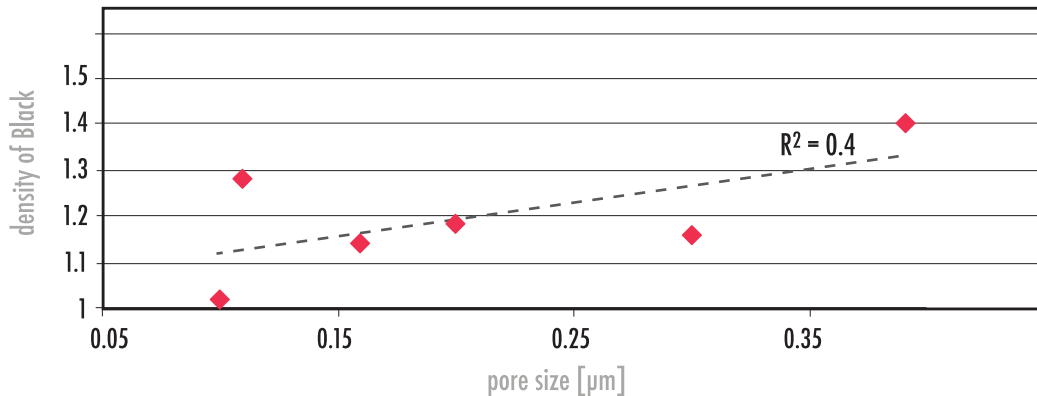

Figure 14. Print density (black) as function of pore size

It seems that samples with high pore volume did not reach high contrast levels, even if the density of the compact surface was increased, as can be seen from Table 8.

Table 8. Measured relative contrast values (75% raster) of black, densities of compact surfaces, pore volume and number of pores

trial point	K rel [%]	densities of compact surface	pore volume [cm^3/kg]	number of pores [$\text{pores}/\mu\text{m}^2$]
1	20	1.4	89	16
2	31	1.1	64	82
3	24	1.2	89	28
4	23	1.2	76	57
5	27	1.0	68	212
6	23	1.3	76	192

Pore structure or coating pigment mixture did not influence the set-off or print-through of the matt LWC paper in this experiment as the results in Paper III show.

4.2 Influence of coating pigment mixture on runnability

Small pore volume resulted in better runnability in this study. As figure 15 shows the total pore volume has a clear influence on the build-up tendency.

Positive CIC build-up as a function of Pore volume

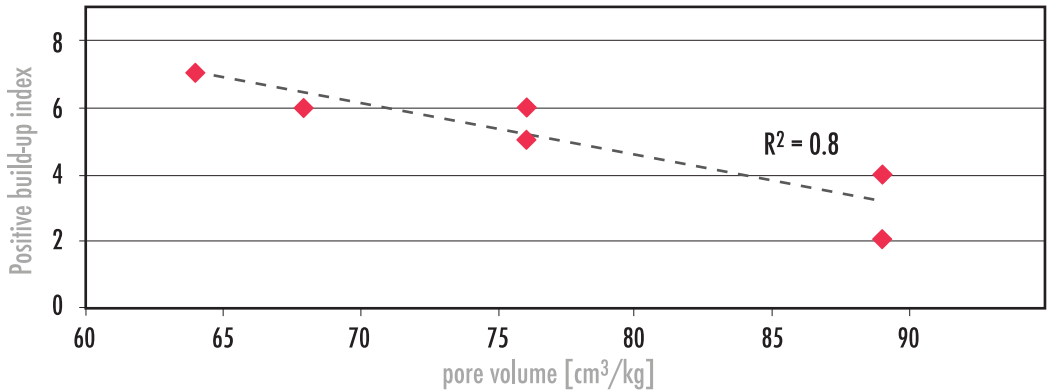

Figure 15. Positive build-up index (higher index=smaller build-up tendency) as function of total pore volume.

Pore volume was not only influenced by coating pigment mixture, but by coating coverage as well. As Figure 16 illustrates the total pore volume tends to decrease as the coating coverage is increasing.

Pore volume as a function of Coating coverage

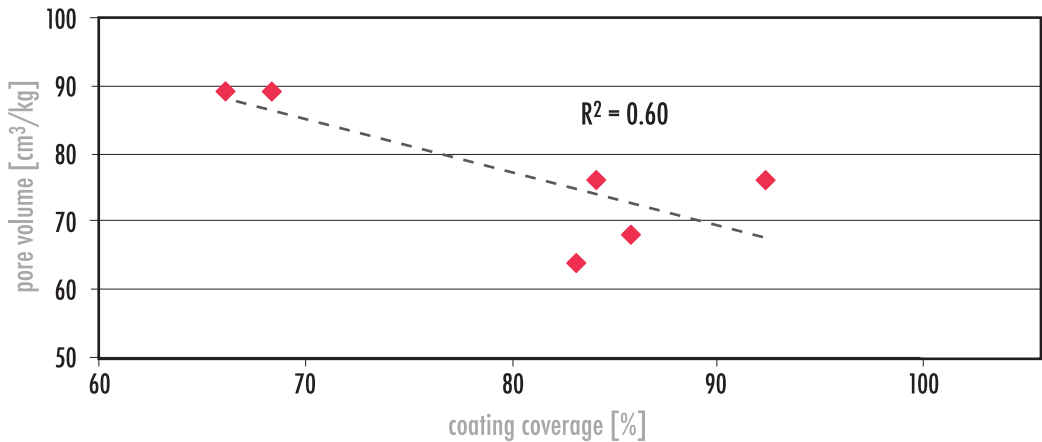

Figure 16. Total pore volume as function of coating coverage (SEM)

Pore size has an influence on the build-up tendency. As Figure 17 illustrates small pores improve the build-up index (less build-up).

Positive CIC build-up as a function of ave pore size

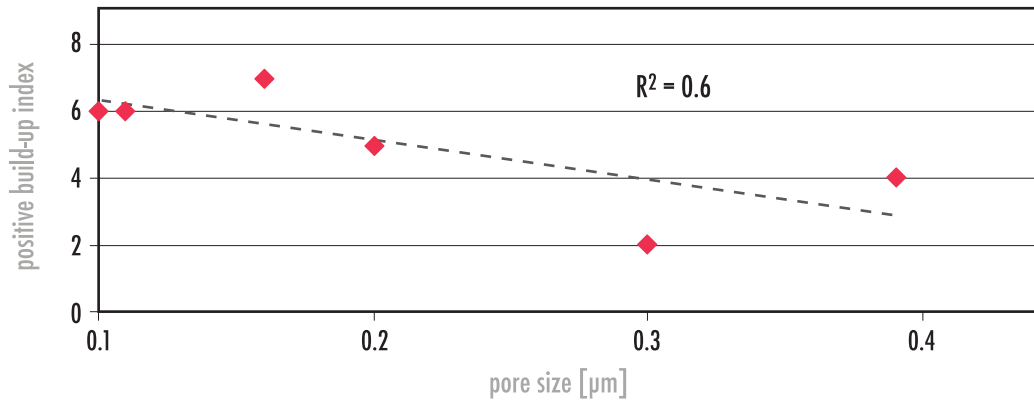

Figure 17. Positive build-up index (higher index=smaller build-up tendency) as function of pore size

4.3 Discussion

It was somewhat surprising that pore structure did not have any influence on set-off or print-through of matt LWC papers in this study. For example, Särelä /21/, suggests in his studies on uncoated paper surfaces that set-off is a function of ink setting, which is influenced by pressure pulse and capillary absorption among other variables. Capillary absorption properties should be influenced by pore size.

The explanation for this can be that the ink film is thinner and thereby the transferred ink volume is smaller on the coated paper surface than on the uncoated. Figure 18 shows the magenta ink film on coated surface. It can be seen from this figure that ink film thickness varies between 0.7 and 7.2 μm . The maximum measured ink film thickness on the coated paper surface is roughly half of the maximum thickness of the comparable ink film on the uncoated surface. More detailed results of the ink film comparisons can be found in Paper III.

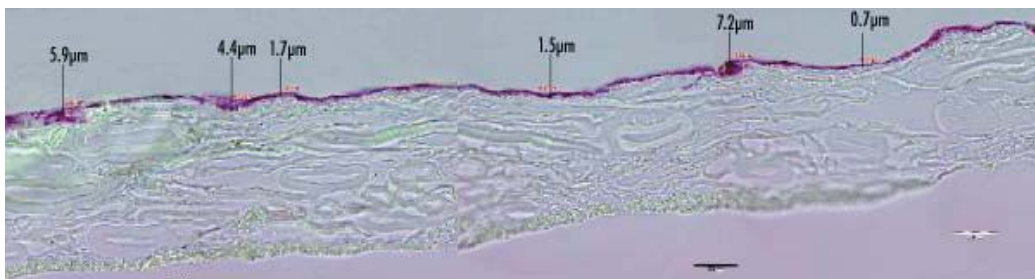

Figure 18. Magenta ink film on coated paper surface and measured film thicknesses

The thinner ink film gives, as a consequence, a small set-off level because there is a smaller quantity of “unset” ink in the surface. It is likely that most of the ink volume has set by separation

of resin and oils from the pigments in the surface of the paper. The reason for differences in ink film thickness on coated and uncoated surface could be that there are differences in the surface area/volume and differences in the shape of voids and pores. It could be that the pores of matt LWC are mostly located inside the paper structure, whereas in the case of uncoated papers, most of the pore volume is coming from the surface voids.

This explanation could be supported by the fact that the measured densities of the printed surfaces on the coated paper increased as pore size increased. The density control of the printing process is not accurate enough to compensate for the small difference in the film transfer condition that occurs when the size of voids and pores changes as function of coating pigment in the printing surface. This leads to a higher transferred ink volume, thicker ink film on paper surface and increased print density. Simultaneously, contrast decreases because the ink starts to spread in an uncontrolled way on the paper surface and the dots no longer remain sharp.

It has to be considered that this result was obtained with a trial where pigment mixtures were carefully selected. Main pigment used in the mixtures was carbonate. All pigments used had relatively round shape and their shape factors were relatively constant. This is most likely one of the reasons why there was minimum required volume of surface space available for the ink. If the surface would have been more closed with more platy type pigments, the set-off levels could have been much higher.

The CIC build-up can be considered as one type of set-off phenomena. The main differences between the set-off of the printing ink on paper and the build-up type set-off are the physical conditions, which create the set-off. On the hard, steel-to-blanket nip of the satellite printing unit, the applied and superimposed radial and circumferential forces are clearly higher than anywhere else in the printing machine. These forces are as well approximately 20-40 % higher as compared to the soft blanket-to-blanket nip configuration of a coldset or heatset press /87/. In these conditions the compressibility and the capacity of the paper structure to absorb energy pulses influence how much material is physically loosened from the paper web and attached to the metal roll surface.

The third and more famous type of force applied to the paper at the exit of the nip are the forces coming from the film-splitting. These forces are largely influenced by the ink setting phenomena as stated in many earlier studies (Särelä /21/, for example). The results of the tack analyses discussed in detail in paper II, give reason to believe that the changes in film splitting forces and the absolute magnitude of these forces are relatively small when compared to the physical forces originating from the linear loads of the printing nip. Table 9 summarizes the magnitude of these forces. Therefore, there is reason to believe, that variables influencing the linear loads at the printing nip and variables influencing the compressibility and conformability of the paper structure play key roles in the set-off phenomena creating CIC build-up. This is the difference between print quality set-off and build-up type set-off.

Table 9. Examples of the values of radial /87/, circumferential /87/ and tack forces applied on the paper web at printing nip

force	calculated or constructional (MAN) value [N/cm]
radial force, steel blanket	80 - 260
radial force, blanket-blanket	65 - 180
circumferential force	0 - 10
tack forces	max. 20

The considerable time spent beside the printing machine during this study gave the possibility to make some observations about the variables potentially influencing the nip forces. Blanket type, packing and nip geometry certainly influence as Table 10 summarizes. Optimization is a complex question, since directions given in Table 11 can be contradictory to print quality optimization, for example.

Table 10. Potential variables influencing forces applied on paper at hard printing nip and their optimization for minimizing the CIC build-up

variable	target
thickness of package underneath blanket	minimize
identification of blanket	minimize
over-dimensioning of CIC on press-design	minimize
speed difference between drives	minimize
exit geometry of paper web	horizontal preferred over vertical

Print-through is on very low level for all tested samples. Print-through is not influenced by the pore structure most likely because of the general low thickness of ink film transferred, resulting in a low volume of oils. Independently of the coating pigment mixture used, paper with high ash content creates such a pore network which gave enough volume for the oil compounds to penetrate in x-y direction as well and thereby sufficiently retarding their transfer through the paper web.

Due to the small amount of repetitions of the trial points throughout this whole study, there is statistically speaking not enough material to claim any correlations with reasonable confidence intervals. Therefore the results presented in this chapter and as well in the later chapters give indicative directions, which are, when possible, supported with physical or chemical explanation. The values of linear correlation are usually given in the figures, but the correlations are only indicated with dotted lines in order to emphasize their indicative nature.

4.4 Summary

Table 11. summarizes the optimized settings of the paper structure of matt LWC for coldset printing from product integrity point of view. These targets are valid when coating pigments are used as a tool to obtain them.

Table 11. Summary of optimized targets for pore structure of matt LWC in coldset printing according to product integrity definition

printed attribute/variable	pore volume	pore size	number of pores	coating coverage
contrast (max)	minimize	minimize	no influence	no influence
dot-gain (max)	minimize	minimize	no influence	no influence
set-off, print-through (min)	no influence	no influence	no influence	no influence
CIC build-up (min)	minimize	minimize	no influence	maximize

The results of this study show that pore volume and pore size should be minimized when using round shaped coating pigments. It has to be remembered that this result is valid only in combination with the base paper used in this study. Further testing with different base paper types could show if these results are valid in wider context.

5 EFFECT OF COATING LATECIES ON INTERNAL PRODUCT INTEGRITY

Build-up rate (positive and negative) of matt LWC grades in CSWO printing is not greatly influenced by single latex variables. No statistical evidence was found to indicate the influence of single latex variables on the build-up rate. As Figure 19 shows, it looks like increasing the particle size of the latex along with improving its interaction with coating pigments, could slightly reduce negative build-up rate.

Negative build-up on CIC surface as a function of latex particle size

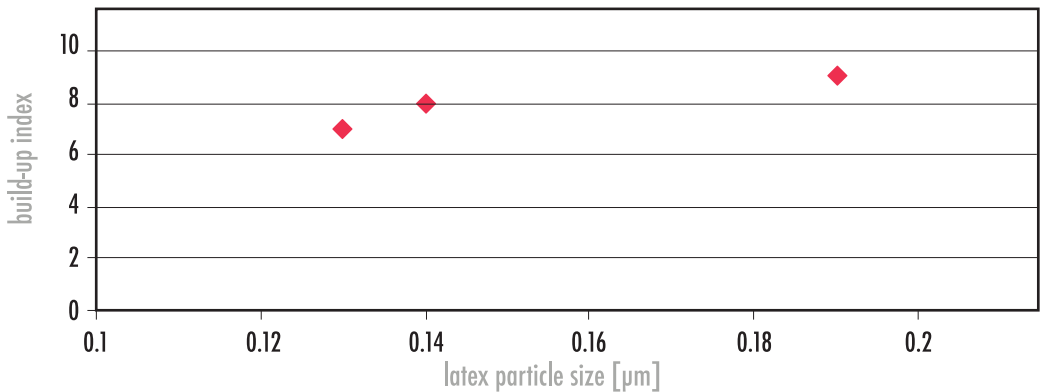

Figure 19. Negative build-up (higher index=smaller build-up tendency) as function of latex particle size

Changes in the degree of cross linking, measured using swelling capacity, degree of softness or particle size of latex did not show any influence to most of the printed paper attributes (contrast, set-off or print-through) in this study. Only dot-gain showed some response to latex variables. Decreasing the minimum film formation temperature of the latex gave slight reduction of dot-gain, as figure 20 shows.

Dot-gain (75% black) as a function of latex properties

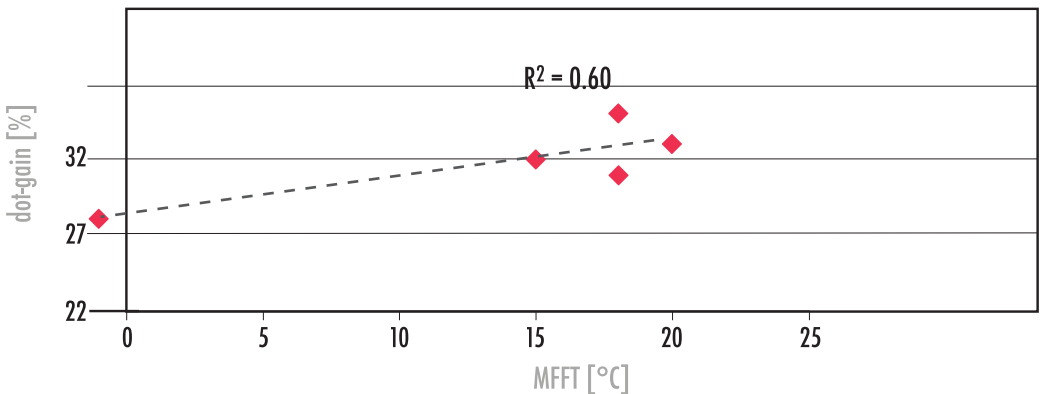

Figure 20. Influence of film formation temperature to dot-gain (75% coverage, black)

Increasing particle size slightly reduces dot-gain, as figure 21 shows.

Dot gain as a function of latex particle size

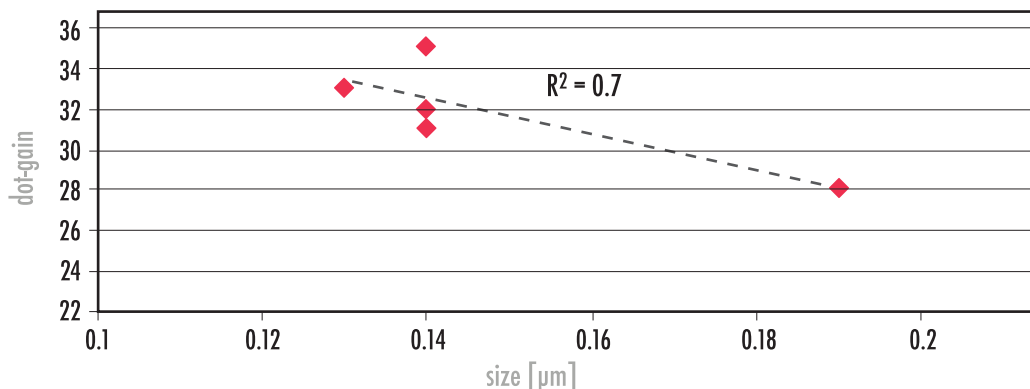

Figure 21. Influence of latex particle size to dot-gain (75% coverage, black)

It was found with Raman analyses that the latex content (latex coverage) in the paper surface and the homogeneity of the surface concentration of latex could have some influence on the CIC build-up tendency. It could be that a minimum “latex coverage concentration” must be reached at the surface layer in order to have low build-up tendency. Raman analyses showed no signs of latex migration. All Raman results can be found in Paper IV.

5.1 Discussion

According to this study, the degree of cross linking, degree of softness or particle size of latex did not have any major influence on the printed paper attributes of matt LWC in coldset printing. Only dot-gain was clearly influenced. Contrary to earlier studies of heatset inks on coated surfaces /39/, this result could indicate that the potential setting mechanisms for coldset inks are not so dependent on latecies in an industrial scale.

There are several potential explanations for this result. It is possible that the dominating separation mechanism for coldset oils in industrial scale printing is pressure pulse rather than diffusion or capillary driven penetration. It could be that in the industrial scale the influence of latecies on the coating structure is smaller than in the controlled laboratory scale experiments. It is also possible, that the influence of latecies is not independent, but in relation to the coating pigments and base paper used. In this latter case, a different experimental design could reveal more details about the influence of latecies on the product integrity of matt LWC in coldset printing.

5.2 Summary

Industrial scale trials showed that the influence of latex variables to product integrity of matt LWC in coldset printing is smaller than could have been expected based on the results of earlier studies. The reason could be that most of the earlier studies had been performed in controlled laboratory conditions, using model surfaces and thick ink films. The film transfer in these studies has most likely been in region III (thick, homogeneous and continuous films), which could have been different than the industrial scale conditions applied in this study. Most likely the transferred ink film in industrial conditions is not homogeneous, thick and continuous.

One other reason could be that the separation mechanisms of oils in coldset inks are different from the separation mechanisms of oils in heatset inks. It could be that the pressure pulse driven penetration is dominating the separation of coldset ink components. In heatset inks the separation is driven by capillary forces, diffusion or pressure pulse as suggested in earlier studies /39/.

6 EFFECT OF BASE PAPER ON INTERNAL PRODUCT INTEGRITY

Bendtsen porosity, oil and water absorption and surface properties of the base paper influence both positive and negative build-up rate. Base paper with higher bulk results in a smaller ink build-up rate (positive and negative) as Figure 22 shows.

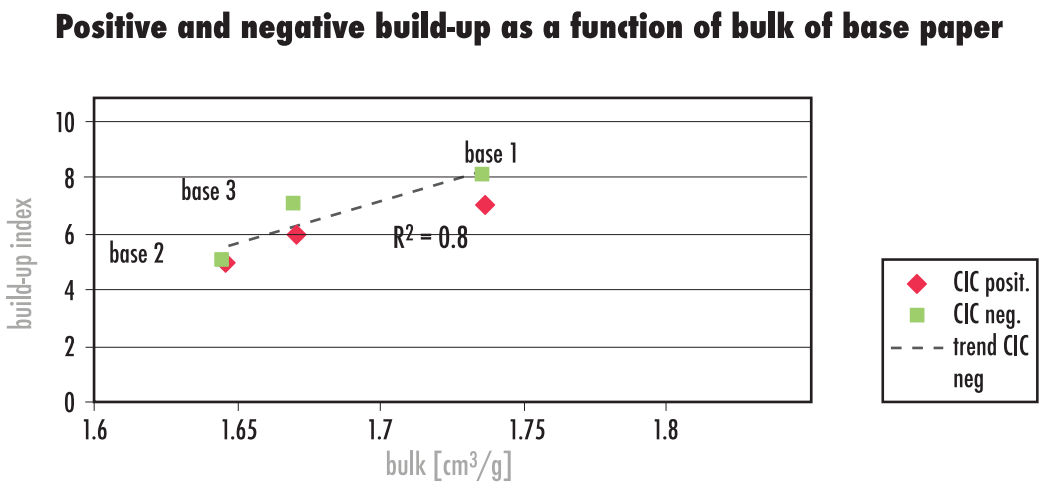

Figure 22. Influence of bulk of base paper to build-up (higher index=smaller build-up tendency)

The absorption properties and free surface volume in the surface of the base paper seems to influence the film transfer in the coating and thereby affect the rate of positive and negative build-up of the final product. High ink absorption and high oil absorption reduce the build-up tendency as can be seen from Figure 23.

Positive build-up as a function of K&N ink apsortion and CU oil absorption of base

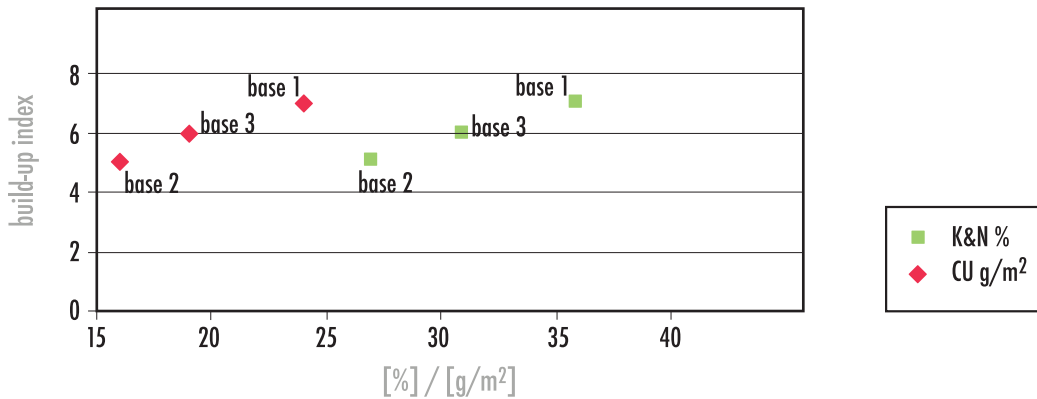

Figure 23. Positive build-up index (higher index=smaller build-up tendency) as function of K&N ink absorption and Cobb-Unger oil absorption of the base paper

Figure 24 shows how porosity of the base paper influences the build-up rate of the final paper. High Bendtsen porosity of base paper decreases the build-up tendency.

Positive and negative build-up as a function of Bendtsen porosity of base



Figure 24. Positive and negative build-up index (higher index=smaller build-up tendency) as function of base paper porosity.

When the fiber raw material was constant, the base paper influenced contrast, print-through and set-off of the matt LWC in coldset. The main variable influencing the printed paper attributes was the ash content of base sheet. It influenced the contrast and print-through. When ash content in the base increased, the contrast of the final product improved, as Figure 25 illustrates. Increasing the ash content in the base paper reduced print-through as well.

Contrast (B75%) as a function of ash in base

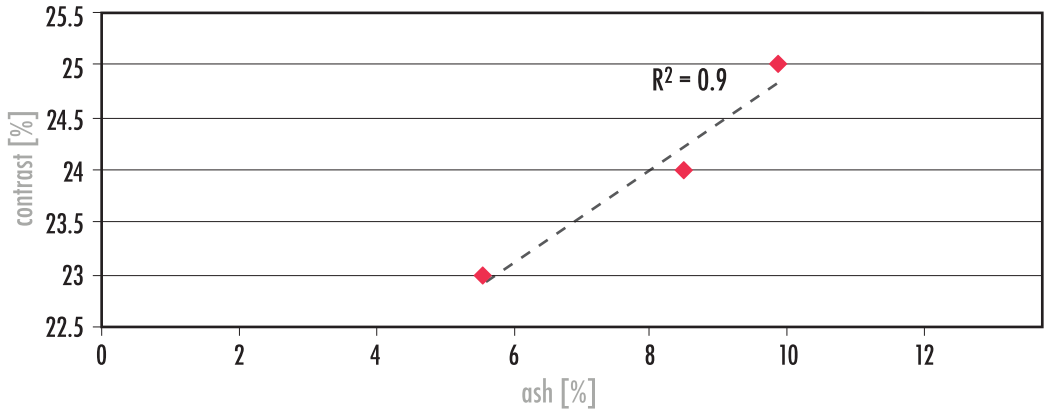

Figure 25. Contrast (75% coverage, black) as function of ash content of base sheet

The dynamic water absorption of the base correlated with the print-through, as shown in Figure 26. Increased dynamic absorption of water into the base paper resulted in increased print-through.

Print-through (B) as a function of dynamic absorption rate of base

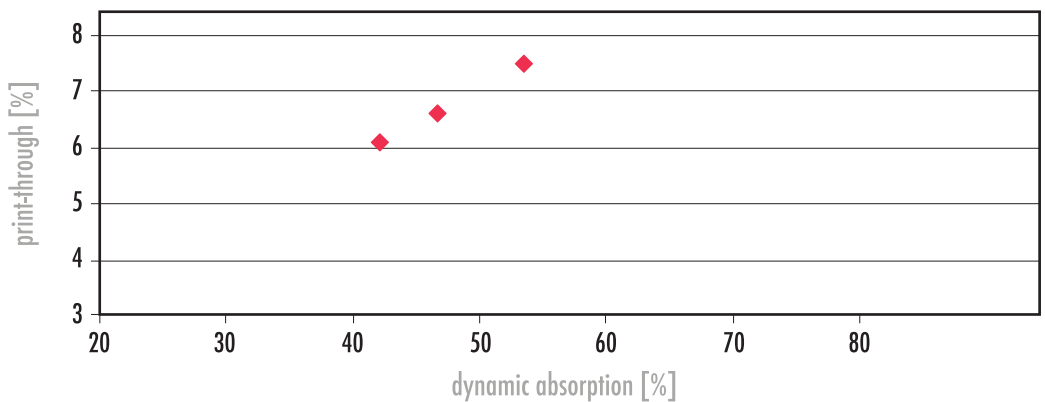

Figure 26. Print-through as function of dynamic absorption of water into base sheet

Set-off was influenced only by base paper formation in this experiment, although it has to be considered that differences in both formation and set-off were small. Figure 27 shows that increased formation index i.e. poorer formation decreased set-off.

Set-off as a function of base formation

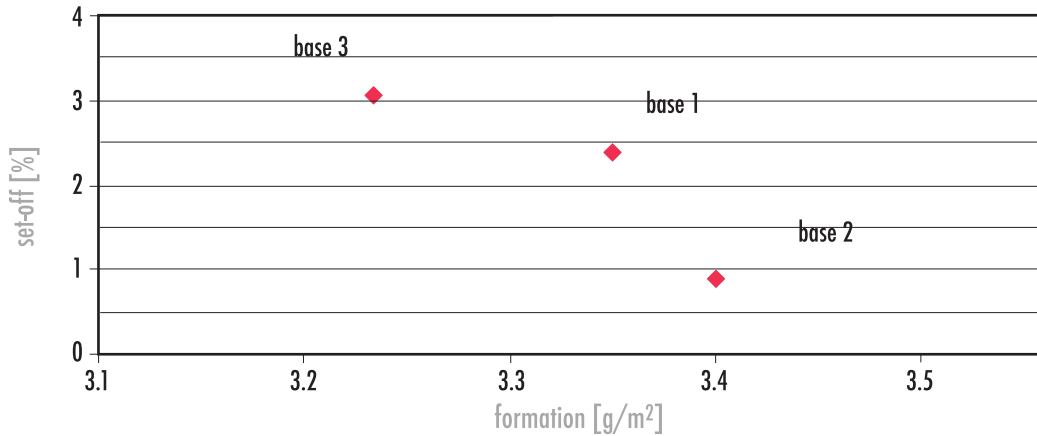

Figure 27. Set-off of commercial printed samples as function of base paper formation index

6.1 Discussion

It was proven that the base paper characteristics influence both printed paper attributes and build-up rate of the matt LWC paper in CSWO printing. Filler content of base paper had the biggest influence on the printed paper attributes. Increasing filler content of base decreased print-through and increased contrast. Set-off was only influenced by formation of base paper. It could be that grammage variation increases the total roughness volume of the surface of the base paper. One potential mechanism could be that increasing local density variations at the surface reduce total pore volume at the surface. This further influences the film transfer in coating and the structure of coating and finally the ink film transfer in the printing nip.

High bulk, high porosity and high absorption of oil in the base paper decreased CIC build-up rate. Most likely bulk is related to contact area during film transfer at coating and later during the film transfer in printing. It can be as well that bulk is an indirect indicator of the paper's structure. Higher bulk can indicate that the paper in this study has better elasticity and compressibility and therefore has a lower build-up tendency at CIC.

Free oil absorption correlates with surface volume. Increasing the surface volume can potentially lead to less penetration of ink oils and resin deeper to the paper, which most likely reduces CIC build-up tendency, as identified with the GPC studies.

Contrary to earlier studies /21/ of uncoated coldset papers, in this study the results of oil or ink absorption tests did not correlate with print-through of the printed samples on a commercial scale. One explanation could be the fact that the laboratory scale absorption tests are done without any pressure pulse. This explanation could indicate that the pressure pulse is one of the main factors influencing oil separation on coated surfaces in coldset printing. When considering water, it could be seen that a quick spreading of a water droplet on the base paper's surface indicates increased print-through of the final product. One explanation could be different dewatering, film transfer and immobilization during coating leading to a different coating structure, which further can influence the penetration depth of ink oils.

It is important to note that the results shown here are obtained with a constant fibre raw material mixture. More detailed analyses in paper II show that there is reason to believe that changes in

the fibre raw material mixture can have some influence on the product integrity of matt LWC in coldset printing.

6.2 Summary

Table 12 summarizes the influence of the most important characteristics of the base paper to the printed paper attributes and build-up rate.

Table 12. Most important base paper characteristics influencing printed paper attributes and build-up rate of matt LWC paper in CSWO printing

	bulk	filler content	Bendtsen roughness	ink abs.	oil abs.	formation	air permeability
build-up rate	xx			xx	xx		xx
set-off						xx	
print-through		xx					
contrast		xx					

It has been proven that the base paper characteristics influence both printed paper attributes and build-up rate of the matt LWC paper in CSWO printing.

7 CORRELATION OF LABORATORY SCALE TESTING TO PRODUCT INTEGRITY ATTRIBUTES

The correlation of the results of laboratory printing tests to printed paper attributes was poor. The only significant correlation could be found to set-off and print-through. In most of the tested cases no correlation between the laboratory analyses and the set-off of the commercially printed samples collected from the folder or at the stacker ie.after mailing department operations, could be found. Even the directions did not correlate. Figure 28 illustrates that the only correlation found was between visual set-off at folder and prüfbau set-off analyses.

Visual set-off vs. Prüfbau delta set-off

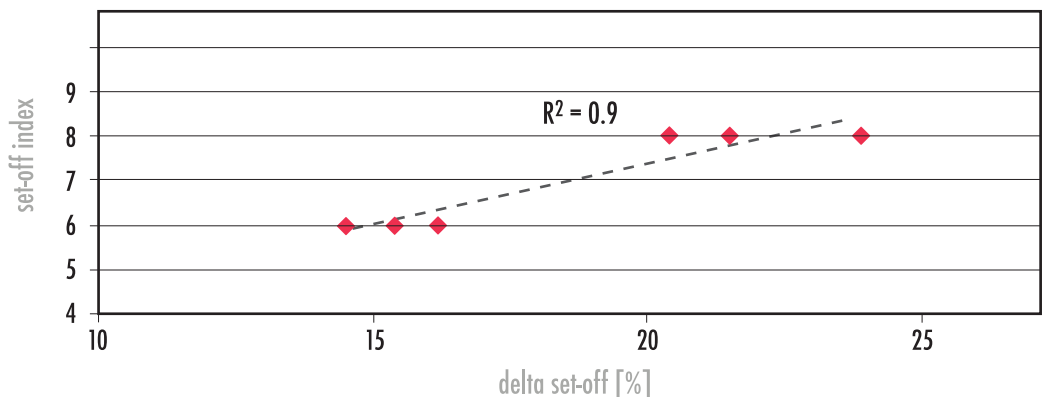

Figure 28. Correlation of Prüfbau delta set-off to Visual set-off (bigger=less set-off) at folder. Prüfbau printing to constant ink 1.5 g/m²

No correlation was found between the Prüfbau set-off results and the set off tendency of the inner pages. As can be seen from Figure 29, the inner page set-off seemed to have a slight decrease, when Prüfbau test ink consumption increased. This result is interesting, but can be considered statistically insignificant.

Set-off vs. Prüfbau ink consumption

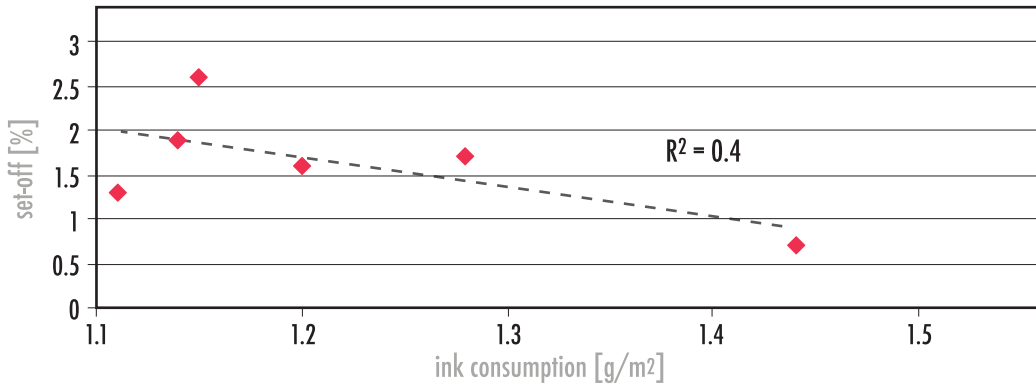

Figure 29. Inner page set-off at folder as function of ink consumption measured with Prüfbau (to Density 1.3)

Print-through of all the printed samples varied between 3.2 and 7.5 %-units. This is such a large difference, that it can be clearly observed visually from the samples. Some correlation between the print-through value of Prüfbau print-through test and print-through of the commercial samples of the same papers exists as figure 30 illustrates.

Print-through vs. Prüfbau print-through

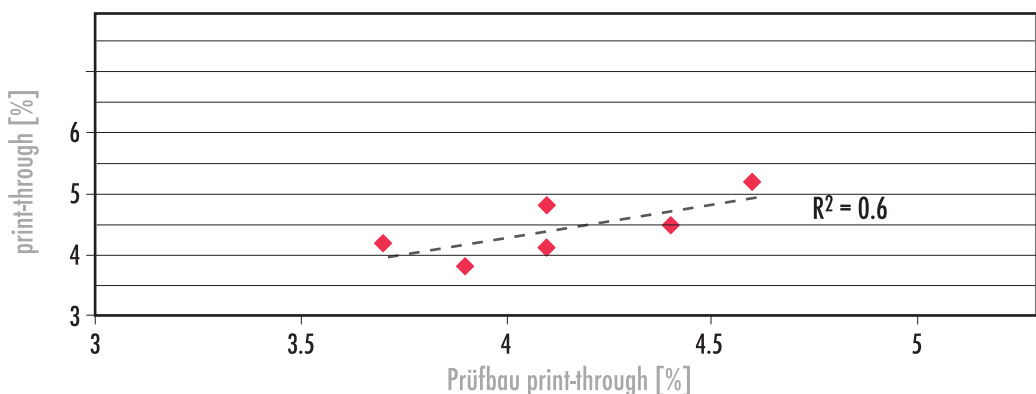

Figure 30. Correlation of Prüfbau print-through result to print-through (Elrepho) measured from commercial samples. Prüfbau printing to constant D1.3

Table 13 shows that if the fibre raw material mixture is constant statistically significant correlations between certain laboratory scale analyses and positive build-up tendency can be found. Pore volume, bulk, K&N ink absorption and coating coverage can be used as laboratory scale tools to give an estimation of the positive build-up rate. No statistically significant correlation between laboratory scale analyses and negative build-up rate was found.

Table 13. Correlation of laboratory scale tests to positive build-up tendency

measurement	correlation to positive build-up (R²)
K%N ink absorption	0.9
Cobb-Unger (5 s) oil absorption	0.9
bulk	0.9
air permeability (Bendtsen)	0.9
pore volume	0.8
coating coverage (SEM)	0.8

More detailed results about the correlation of laboratory scale testing methods to the product integrity of matt LWC papers in coldset printing can be found in Paper I.

7.1 Discussion

It is suspected that the different analyses presented in Table 13 give different responses to different modifications in paper. It could be proposed that structural tests like pore volume give good response to changes in filler or coating pigment type or quantity, which influences further the build-up tendency. On the other hand it can be seen that pore volume is not sensitive to changes in fibre raw material, even though changes in fibre raw material can also lead to a different build-up tendency. The test series in this study were not statistically big enough to prove this hypothesis. The origin or the cause of the paper technological changes was not controlled in this investigation. Therefore, a new test series with different testing methodology is needed in order to find out what papermaking variables influence and contribute to the given structural and absorption properties listed in Table 13.

In order to carry out product differentiation work for coldset printing products based on the product integrity concept, the only suitable tool existing today for the paper maker is a commercial scale coldset printing machine. Without trials and testing on a commercial scale, the technical product development has limited possibilities to economically and efficiently match the requirements of customer driven product differentiation process.

The conventional laboratory scale printing tests for coldset printing papers are generally not very suitable for matt LWC products. The optical print properties of coated papers are so far away from uncoated products. For example, the set-off levels of coated coldset products are more than 50% lower than uncoated products, which means that the tests must be sensitive to very small changes in low set-off levels.

On the other hand the test methods widely used for coated paper grades in heatset printing are not suitable either. This is mainly due to the large fundamental differences between the coldset and heatset printing processes (nip forces, rheology of inks, etc.). Methods like ISIT work well for heatset inks, but have to be further developed for coldset inks.

7.2 Summary

Best tools for first steps in rough scale development work are offered by air permeability analyses, bulk, coating coverage, mercury pore volume, Cobb-Unger oil absorption and K&N ink absorption tests. The difficulty lies in the sensitivity of these tests. They can not be used blindly for all development work as one has to know which test is to be used in connection with a specific paper technological variable. These tests do not cover the whole range of paper technological variables.

For example, they do not respond well to changes in fibre raw material. It can be concluded that we do not have today a set of laboratory scale technical tools, for product development of matt LWC grades for coldset printing that could lead to a sufficient product differentiation process. Therefore the industrial scale testing has to be used in the product differentiation process. The direct costs of industrial scale tests are often higher than in laboratory scale, but the risk of failure in the performance of a new commercial product is much smaller. The duration of the differentiation process is also shorter when industrial scale trials are used. Both these factors mean that in most of the cases the total cost of the development work is less when industrial scale testing is used at selected step of the differentiation process instead of laboratory scale testing.

8 EVALUATION OF PRINT QUALITY POTENTIAL OF THE COLDSET MARKET

A separate printing test was carried out in order to evaluate today's situation of the print quality potential of three different printing methods. This test consisted of three separate printing sessions in coldset (Wifag OF 790), in waterless coldset (KBA Cortina) and in heatset. The test formats used and other details of the test can be found in Paper III. Table 14 summarizes the commercial trial papers used. Trial papers A-E are sold in the market to coldset printing and grade C to heatset and rotogravure printing (multipurpose). Grade F is a MFC paper for heatset printing.

Table 14. Summary of the commercial paper grades evaluated in printing test

trial paper	description	brightness (D65)	CIE whitness	roughness Bendtsen [ml/min]
A	coated grade, in CSWO	80	>90	<200
B	uncoated in CSWO, RCF containing medium filler content	70	60	>200
C	uncoated, multipurpose, printed in CSWO, virgin fiber, low filler content	73	65	<50
D	uncoated in CSWO, RCF containing, high filler content	76	80	<200
E	uncoated in CSWO, virgin fiber based low filler content	76	70	<150
F	coated (MFC), in HSWO, virgin fiber, high filler content	72	66	<150
G	grade F printed in waterless cold set (KBA Cortina)	72	66	<150

The commercial papers used today in the coldset market are very different in paper technical characteristics as Table 14 shows. The market is very diversified and therefore it was necessary to run a printing test in order to evaluate the print quality potential that coated paper grades can bring to the coldset market.

As the results in Figures 31 and 32 show coated grades printed with coldset printing technology can reach final print quality, which is comparable to certain matt heatset end qualities. Only density and gloss of printed surface remain below the heatset level.

Waterless coldset seems to improve the overall print quality; particularly contrast as Figure 31 shows. Usually the human eye can see differences above five %-units in contrast measurement. The circle in Figure 31 shows the superior contrast level of tested papers in waterless coldset. The printing method did not have much influence in reproducibility of colors or in evenness of printed surface as can be seen from Figure 31.

Reproducibility of colors, evenness of solid areas and contrast

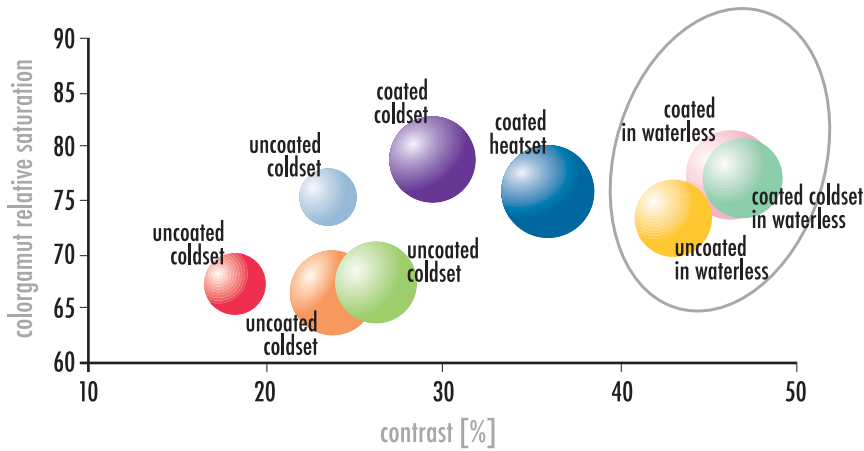

Figure 31. Reproducibility of colors, contrast and evenness of printed surfaces (bigger bubble=more even) of coated and uncoated commercial paper grades printed in coldset, waterless coldset and heatset. Waterless coldset results are circled

The visual sharpness (less dot-gain) of images was improved when water was excluded from printing. Improved dot-gain values are illustrated in Figure 32. The difference between uncoated and coated printing surface become smaller in waterless printing. Print-through was smaller for uncoated grades in waterless coldset, but no difference in print-through was noticed for coated grades (Figure 32).

There are very big differences in set-off levels between printed paper samples produced in conventional coldset. As Figure 32 shows, the set-off level of the worst sample printed in conventional coldset is four (4) times higher than that of the best coldset sample. In waterless coldset, the set-off level of the inner pages is low, but the set-off in the front page coming from the mailing department operations is clearly higher than in conventional coldset samples. This disturbed the final print quality, particularly the cleanliness of the margins of the front page. The arrow in Figure 32 shows this set-off level, which was not observed in conventional coldset or heatset samples. More specific results of print quality of these paper grades can be found in paper III.

Set-off, dot-gain and print through

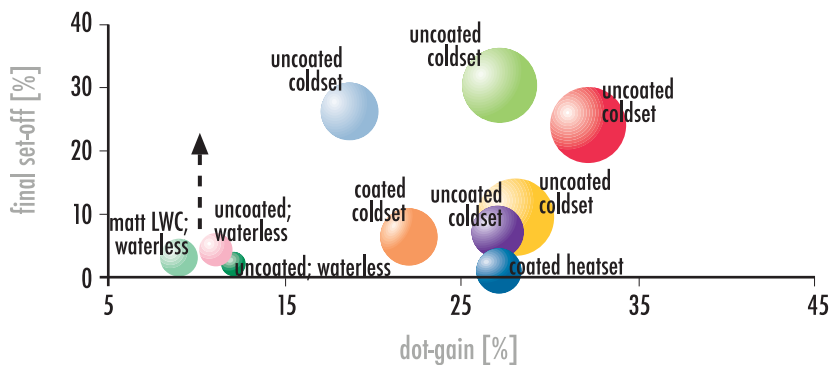

Figure 32. Set-off, dot-gain and print-through (smaller bubble=less print-through) of coated and uncoated commercial paper grades printed in coldset, waterless coldset and heatset

More specific results of print quality of these paper grades can be found in appendix III.

8.1 Discussion

The analyses of the print quality potential of conventional coldset process showed that the print quality results are very diversified. Commercial uncoated paper grades sold today in the market place give very different print quality results. It is essential for the printer to understand the print quality requirements of his product and then test which paper grades fulfil the given requirements. It is not possible to generalize the coldset print quality.

The results of the print quality testing showed that matt LWC printed in coldset reaches such a qualitative level according to the internal product integrity definition that it allows the printer to exceed the technical obstacles by which the new business models are often confronted. With coated grades the newspaper publishers can switch certain products from heatset to coldset presses. Due to the high contrast values and low dot-gain level, finer screen rulings and new imaging technologies (Shandy screening, Frequency modulations, etc.) can be efficiently used, which results in increased sharpness of the images. Therefore, matt LWC gives possibilities for new visual design and thereby possibilities for new business models and further exploitation of the coldset printing capacity. The critical step for the publisher in creating new business models or in switching existing products from heatset to coldset is to recognize the key product properties and their required qualitative level.

The results from waterless coldset printing show that it is possible to further improve the dot-gain and contrast in the final product, if an investment is done in new machine technology. The coated printing surface seems to keep slight advantages over the uncoated surface in waterless technique as well. The quality potential of the waterless concept was disturbed by higher set-off than in conventional coldset process.

9 CONCLUDING REMARKS

The results of this study showed that customer driven product differentiation process of a printing paper manufacturer requires new kind of testing tools. The traditional tools, which are largely based on laboratory scale testing are too slow and create a major problem and risk when scaling the findings to an industrial scale. The errors and time lost in the scaling phase increase the total cost so much that industrial scale testing of a product before a market launch could become economically more efficient at the end. The findings of the experimental part of this work suggest that the printing paper manufacturers should shift the technical testing at suitable stage of the differentiation process to industrial scale from laboratory scale. Creation of a new product in printing paper industry could approach the standard concurrent engineering processes, which include testing phase of the new product in industrial scale after the innovation phase, but before market launching /88/.

It was found that coated paper grades in coldset printing offer such an improvement of the printed paper attributes that it allows newspaper publishers to overcome some of the technical barriers, ie. high set-off tendency, print-through or dot-gain, hindering the expansion of their businesses.

Results of this study showed that coating pigments and base paper properties have influence on internal product integrity of matt LWC paper in coldset printing. The influence of coating pigments as a single variable in the fine tuning of the internal product integrity was smaller than expected based on earlier findings from heatset printing. It is suspected that the influence of coating pigments

in the internal product integrity is depending on the base paper properties. A natural area for future studies would be to identify the most important paper technological variables influencing the internal product integrity via base paper properties.

Latex properties as single variables did not have clear influence on internal product integrity. It could be seen that latex coverage has some influence to the internal product integrity. Therefore, experimental designs profiting latex properties as multivariable parameters could bring new knowledge to the fine tuning of the internal product integrity.

The verification of the hypothesis of this work can be summarized as follows:

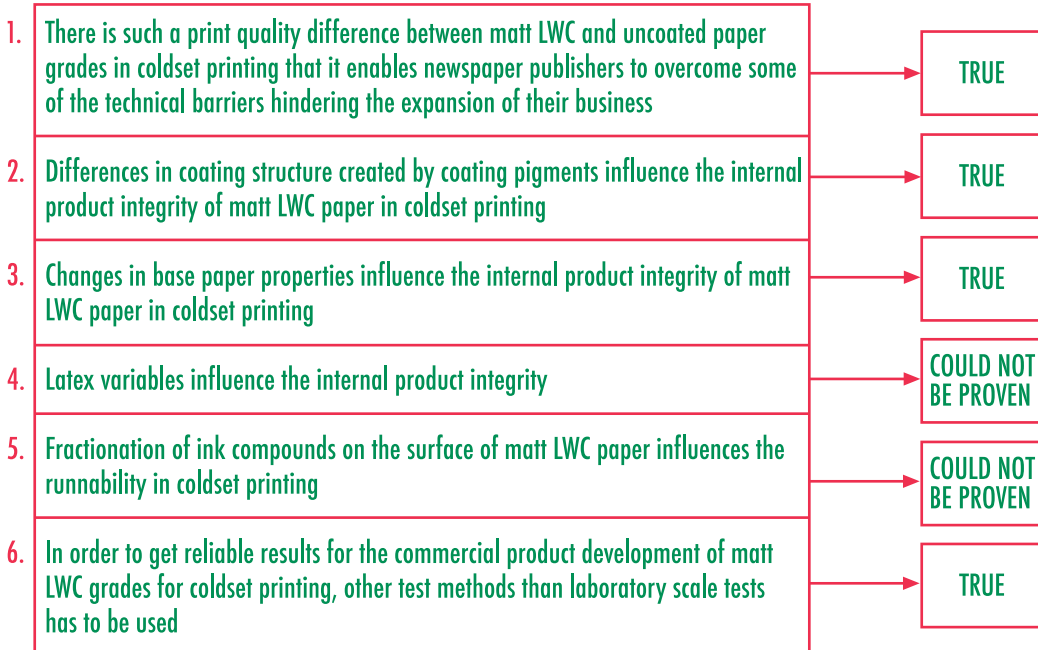

New printing machine technologies (waterless coldset) gave promising results on print quality. The investment in new machinery is usually often heavy. The comparison of new machine investment against improved printing surface as a tool for better exploitation of new business models is not included in this study. In general it is likely that the utilization of a coated paper grade brings new costs as well when compared to utilization of uncoated grades. The comparison of the investment costs and the increased cost related to utilization of coated grades in existing machinery were not done in this study. Both should be evaluated against the increased profit potential of new business models that they open the doors to.

Even if improved printing surface solves technical obstacles related to new business models, there are other factors remaining, which will shape the life cycle of newspaper publishing as well. The market will continue to develop with significant regional and publisher specific differences. It is up to the publishers to make their choice; they can extend the lifecycle of their product indefinitely if they change its content, presentation and delivery in important ways. Or they can lead it into the dustbin of history if they continue to operate according to business as usual /1/.

REFERENCES

1. CEPIPRINT, Amec study on The future of newspapers, November 2003.
2. WAN, World of Association of Newspapers, Shaping the future of the newspaper, strategy report, May 2002.
3. POROPUDAS, L., Use of Magazines; contextual study in Finland. KCL Reports 2746, August 2004, 56 p.
4. HAARLA, A., "Product Differentiation: Does It Provide Competitive Advantage for a Printing Paper Company?" Dr Sc Thesis, Helsinki University of Technology, Helsinki, Finland 2003
5. JERNSTRÖM, E., Assessing the Technical Competitiveness of Printing Papers, Dr Sc Thesis Lappeenranta University of Technology, Lappeenranta, Finland 2000.
6. FORSELL, M., AIKALA, M., SEISTO, A., NIEMINEN, S., End user's perception of printed products, Pulpaper 2004, June 1-3, 2004, Helsinki Finland, p. 41-46 (coating book)
7. MACKAY, A., WRIGHR, A., Correlation between laboratory printability testing and commercial printing, 50th APPITA annual general conference, 6-10 May 1996, Auckland, NZ, vol. 2, p. 405-407
8. DALPHOND, J.E., ASPLER, J.S., DEGRÂCE, J.H., JORDAN B.D., Relation Between the K&N Test and Printability Tests for Newsprint, Tappi Journal, 77 (1994):10, p.97-103
9. KARTTUNEN, S., Using Statistical Methods in Studies on Printing Technology, Symposium of Soviet and Finnish printing technology scientists, April 1-3, 1974, Moscow, USSR, p.23-27
10. THOYER, B., LAMY, B., Runnability and Printability of Newsprint, IFRA Special report 1.16, Darmstadt, Germany, 1996
11. HEINTZE, H.U., RAVARY, R.E., VAN WAGNER, J.S., A Laboratory Test to Predict Offset Printability Problems with Coated Paper, International Printing and Graphic Arts Conference, Pittsburgh, PA, USA, October 18-21, 1992, p.23-31.
12. KARTTUNEN, S., LINDQVIST, U., Test Printing of Papers on Pilot and Full Scale, Tappi Printing and Reprography conference, Chicago, IL, USA, Nov 10-12, 1980, p.1-5
13. LEE, D.M., TRIANTAFILLOPOULOS, N.G., Testing Paper and Ink Interaction: a Tool for Quality Assurance of Coated Papers, Tappi Process and Product Quality Conference, Cincinnati, OH, USA, Oct 14-17, 1996, p.163-174
14. GOODING, R.W., JORDAN, B.D., MACPHERSON, S.C., Use of 3D Profilometry to Assess Offset Printability, 87th annual meeting of PAPTAC, Jan 31, 2001, Canada.
15. HOHTARI, H., MASSOLT, P., Pressroom Simulation: New Laboratory Scale Testing Methods for Investigating Ink/Paper Interaction in Modern Newsprint, 57th Appita annual conference, Melbourne, Australia, May, 5-7, 2003, p. 471-473.

16. MANGIN, P.J., DE GRÂCE, J.H., A New Method for Evaluating the Printing Characteristics of Newsprint, International Printing & Graphic Arts/Testing Conference, Niagara Falls, NY, USA, Oct 23-25, 1984, p. 135-143.
17. NORDSTRÖM, J-E.P., HOC, M., MANGIN, P.J., A Laboratory Waterless Ink Transfer Evaluation for coated Papers using the Prüfbau Printability Tester, TAPPI Advanced Coating Fundamentals Symposium, Philadelphia, PA, USA, May 9-10, 1997, p. 253-281
18. WOODALL, M.L., Laboratory Print Quality Testing-What is It Worth?, *Appita* 2(44), 1990, p. 126-132.
19. LUUMI, R., Prediction of Deposit Build-up Tendency on the Common Impression Cylinder in CSWO Printing of Coated Paper, M.Sc. Thesis, Espoo, Finland 2002.
20. NORDSTRÖM, J-E., GRÖN, J., Thin-film transfer in printing and coating, PFT Report 39, 1998. 16 p.
21. SÄRELÄ, S., Uncoated paper surface for coldest web offset printing; Set-off Studies, Dr Sc Thesis, Department of Forest Products Technology, Helsinki University of Technology, Espoo, Finland, 2004, 130 p
22. LYNE, M.B., The Mechanism of backtrap mottle, International Printing and Graphic Arts Conference, Le Chateau Laurier, Ottawa, Canada, October 21-23, 1986, p.87-93
23. WALKER, W.C., FLETSKO, J.M., Of Ink Transfer in Printing, *American Ink Maker*, 33(1955):12, p. 39-44, p.69
24. LYNE, B., Machine-calendering: Implications for surface structure and printing properties, *Tappi* 59(1976):8, p.101-106
25. De GRÂCE, J.H., DALPHOND, J.E., The Development of Print Density and Print Through in Newsprint, TAGA 1989 Annual conference Proceedings, Orlando Florida, USA, p. 582-607
26. LYNE, M.B., The Importance of Extensional Viscosity in the Impression of Ink into Paper During Printing, *Advances in Printing Science and Technology*, 20th Research Congerence of the International Association of Research Institutes for the Graphic Arts Industry, September 1989, Moscow, USSR, p. 236-248
27. LYNE, B., Measurement of the Distribution of Surface Void Sizes in Paper, *Tappi Journal*, 59(1976):7, p. 102-105
28. MANGIN, P.J., BELAND, M-C., CORMIER, L.M., Paper Surface Compressibility and Printing, International Printing and Graphic Arts Conference, October 17-20, 1994, Halifax, Canada, p.19-31
29. De GRACE, J.H., MANGIN, P.J., A Mechanistic Approach to Ink Transfer, part 1: Effect of Substrate Properties and Press Conditions, *Advances in Printing Science and Technology*, Edited by W.H.Banks. Pentech Press, London, vol 17(1984), pp. 312-332.

30. De GRACE, J.H., MANGIN, P.J., A Mechanistic Approach to Ink Transfer, part II-The Spitting Behaviour of Inks in Printing Nips, *Advances in Printing Science and Technology*, vol 19(1988), p.146-161.
31. MANGIN, P.J., BELAND, M-C., CORMIER, L.M., A Structural Approach to Paper Surface Compressibility-Relationship with Printing Characteristics, *Transactions of 10th Fundamental Research Symposium*, September, 1993, Oxford, UK, edited by C.F.Baker, p.1397-1427.
32. MANGIN, P.J., GEOFFREY, P., Printing Roughness and Compressibility; a Novel Approach Based on Ink Transfer, *Advances in Printing Science and Technology*, 20th Research Congerence of the International Association of Research Institutes for the Graphic Arts Industry, September 1989, Moscow, USSR, p.249-265
33. TAYLOR, J.H., ZETTLEMOYER, A.C., Hypothesis on the Mechanism of Ink Splitting During Printing, *Tappi* 41(1958):12, p.749-757.
34. MULLER, M. Management zwischen Heatset und Coldset, *Deutscher Drucker*, February 2001 nr 6, p.36-40
35. MULLER, M., Akzidenzrollenoffsetdruck auf Zeitungspapier, *Druckspiegel*, 56(2001):3, p.34.
36. RIEBEN, F., ARNORLD, M., BEIVI, E., BURRI, P., Verhalten von Pigmentierten Papieren im Konventionellen Zeitungsdruck, 18th PTS Coating Symposium, 16-19 Sept, 1997, Munich, Germany, p. 108-113.
37. WERFEL, M., BEIVI, E., BOWER, H., BOETTCHER, G. W., FABRE, F., HUHTANEN, H., KALELA, E., Value Added Coldset, *IFRA Special Report 1.20*, Darmstadt, 2001
38. HÄMÄLÄINEN, M., Spray Coating Technique as a Surface Treatment for Woodcontaining Paper Grades, Dr Sc Thesis, Lappeenranta University of Technology, Lappeenranta, Finland 2002.
39. ROUSU, S., Differential absorption of offset ink constituents on coated paper, PhD Thesis, Faculty of Chemical Engineering, Åbo Akademi University, Turku, 2002, 102p.
40. DESJUMAUX, D.M., The influence of coating and ink properties on ink setting rate on coated paper, PhD Thesis, The Graduate School, University of Maine, Maine, Canada 1999. 254p.
41. MATTTILA, U., TAHKOLA, K., NIEMINEN, S., KLEEN, M., Penetration and separation of ink resin and oils in uncoated paper studied by chromatographic methods, 11th IPGAC, Bordeaux, France, Tappi Press, 2002
42. KENT, H.J., LYNE, M.B., On the penetration of printing ink into the paper, *Nordic Pulp and Paper Research Journal* 2(1989):2, p.141-145.
43. TRUMAN, A.B., HUDSON, F.L., The Rheological behaviour of paper and ink in the offset printing process, *Pulp and Paper magazine of Canada*, 62(1962):6, p. T299-T306.

44. XIANG, Y., BOUSFIELD, D.W., HAYES, P.C., KETTLE, J., A model to predict ink-setting rates based on pore-size distributions, *Journal of Pulp and Paper Science* 30(2004):5, p.117-120
45. TRIANTAFILLOPOULOS, N., LEE, D. and AVE'LALLEMANT, T., Coated paper and offset ink interactions, International printing and graphic arts conference, September 16-19, 1996, Minneapolis, MN, USA, p.97-110
46. ASPLER, J.S. and LEPOUTRE, P. The transfer and setting of ink on coated paper: a review, Symposium on Papercoating Fundamentals, May 17-18, 1991, Montreal, Canada, p. 77-98
47. ENGSTRÖM, G., MORIN, V., BI, S.L., Analysis of porosity distribution in coating layers. *Tappi journal* 80(1997):5, p.203-209
48. GANE, P.A.C., SCHOELKOPF, D.C., SPIELMANN, G.P.M., RIDGWAY, C.J., Fluid transport into porous coating structures: some novel finding, *Tappi Journal*, 83(2000):5
49. STRÖM, G., GUSTAFSSON, J., SJÖLIN, K., Absorption of ink Oils into Coatings after Prüfbau Printing, International Symposium on Paper Coating Coverage, February 16-18,1999, Helsinki, Finland, p.1-11
50. VAN GILDER, R.L. and PURFEEST, R.D., Commercial six-color press runnability and the rate of ink-tack build as related to the latex polymer solubility parameter, *Tappi Coating Conference*, May 1-5, 1994, San Diego, CA, USA, p. 229-241
51. SANTOS, N.F., VELHO, J., GOMES, C., Influence of Calcium Carbonate Coating Blends upon Paper Properties, Ibroamerican congress on pulp and paper research October 18-20 2000, Iguazu, Argentina, 12 p.
52. PRESTON, J.S., The influence of Coating Structure on the print gloss of Coated Paper Surfaces, PhD Thesis, Faculty of Science, University of Bristol, UK, 2001, 233 p.
53. BROKLOVÁ, M., HOLICKÁ, H., KAPLANOVÁ, M., Study of the Printability of Matt Papers by means of Photoacoustics, 27th Research Conference of the International Association of the Research Institutes for the Printing, Information and Communication Industries, 10-13 Sept, 2000, Graz, Austria, edited by Bristow, J.A., p.121-132
54. BOHAN, M.F.J., CLAYPOLE, T.C., GETHIN, D.T., MEGAT AHMED, M.M.H., A Model for Ink Impression in Printing Contacts, *Journal of Pulp and Paper Science*, 26(2000):11, p.414-419
55. SCHOELKOPF, J., GANE, P. A. C., RIDGWAY, C. J., SPIELMANN, D. C., AND MATTHEWS, G. P., Rate of vehicle removal from offset inks: a gravimetric determination of the imbibition behaviour of pigmented coating structures, *Tappi 2001 Advanced Coating Fundamentals Symposium Proceedings*, San Diego, Tappi, Atlanta, 2001, p1-18
56. SCHOELKOPF, J., GANE, P. A. C., RIDGWAY, C. J., AND MATTHEWS, G. P., Influence of Inertia on Liquid Absorption into Paper Coating Structures, *Nordic Pulp and Paper Research Journal*, 15(5), 2000, p. 422-430

57. BACKFOLK, K., GRANKVIST, T., EKLUND, D., The Effect of binder chemistry on the colloidal stability of calcium carbonate suspensions, 2001 Advanced Coating Fundamental Symposium, 3-5 May, 2001, San Diego, USA, p. 149-160.
58. HUANG, Y., SANDERS, N., FOWKES, F., LLOYD, T., The impact of surface chemistry on particle electrostatic charging and viscoelasticity of precipitated calcium carbonate, 1991 Tappi coating conference, May 19-22, 2001, Montreal, Canada, p.123-129.
59. CHONDE, Y., ROPER, J., SALMINEN, P., A review of wet coating structure: pigment/latex/cobinder interaction and its impact on rheology and runnability, 1995 Coating Fundamentals Symposium, 19-20 May, 1995, Dallas, USA, p.57-62
60. GRÖN, J., KUNI, S., The impact of different coating pigments and molecular weight of carboxy methyl cellulose on coating structure, 1995 Tappi Coating conference, May 19-20, 1995, Dallas, USA, p.447-457.
61. FORSSSTRÖM, U., Interactions between base paper and coating color in metered size press coating. Dr Sc Thesis, Department of Forest Products Technology, Helsinki University of Technology, Espoo, Finland, 2003, 99 p.
62. HEDMAN, A., WIKSTRÖM, M., RIGDAHL, M., Assessment of the causes of a print defect in a film coated LWC-paper. Nordic Pulp and Paper Research Journal 16 (2001):4, p.266-283
63. TREFZ, M., Theoretical aspects and practical experiences for film coated offset grades. Tappi journal 79(1996):1, p.223-230
64. AHLROOS, J., ALEXANDERSSON, M., GRÖN, J., Influence of base-paper filler content and precalendering on metered film press coating-paper and print quality. Tappi journal 82 (1999):5, p. 94-100
65. ZOU, X., VIDAL, D., ALLEM, R., Film press for pigment coating:coated paper quality and basestock effects. TAPPI Metered Size Press forum IV, May 1-4, 2002, Orlando, Florida, USA, p.159-170
66. GRÖN, J., AHLROOS, J., Effect of base paper filler content and pre-calendering on coating color mist and coverage in MSP coating. Journal of Pulp and Paper Science 27(2001):2, p. 66-73
67. VARSA, P., ANTTILA, T., TOPPILA, M., The quality of high deinked pulp content magazine paper produced with various coating methods. TAPPI Coating Conference, May 2-5, 1997, Philadelphia, PE, USA, p.281-290.
68. AHLROOS, J., GRÖN, J., A comparison of SGW and TMP as fiber raw material for film coated LWC. TAPPI Coating Conference, May 3-5, 1999, Toronto, ON, Canada, p. 481-500.
69. DRAGE, G., VAUGHAN, C., HENDERSON, K., PARSONS, J. AND HIORNS, T., The influence of freesheet and groundwood basepaper formation on coated and printed paper properties. TAPPI Coating Conference, May, 3-5, 1999, Toronto, ON, Canada, p. 469-479.
70. GANE, P.A.C., BAUMEISTER, M., HOOPER, J.J., A Determination of the Influence of FURNISH Content on Formation and Basesheet Profile Stability during Coating, Tappi coating conference, May, 19-22, 1991, Montreal, Canada, pp 157-168

71. ZOU, X., ALLEM, R., UESAKA, T., Relationship between Coating Uniformity and Basestock Structures part 1: Lightweight Coated Papers, Paper Technology, 42(2001):5, p. 27-37.
72. SILVY, J., CARET, C., BELAMAALEM, B., MAHROUS, M., The Three-dimensional Structure of Paper: Methods of Analyses and Implications on his Physical Properties, International Paper Physics Conference, September 11-14, 1995, Niagara-on-the-Lake, Ontario, Canada, p.91-95
73. SILVY, J., Modelisation des Écoulements dans les Milieux Poreux, Récents Progrès en Génie des Procédés, Diffusion Lavoisier Tech. et Doc., 3(1989)7, p. 506-514
74. NESS, C., GÖTTSCHING, L., New Screening Methods and their Requirements for the Printability of Paper, 27th Research Conference of the International Association of the Research Institutes for the Printing, Information and Communication Industries, 10-13 Sept, 2000, Graz, Austria, edited by Bristow, J.A., p.133-151
75. NINNESS, B., TRIANTAFILLOPOULOS, N.G., Fluid Dynamics Model of the Film-Fed Rolling Nip with a Porous Web, Tappi Coating/Papermakers Conference, May 4-6, 1998, New Orleans, USA, p.515-530
76. SUNDQVIST, H., MSc Thesis, Helsinki University of Technology, 2003, Espoo.
77. VYÖRYKKÄ, J., Confocal Raman Spectroscopy in the Depth Profiling of Paper Coating Colours, M.Sc. Thesis, University of Oulu, Department of Physical Sciences, Oulu, Finland, 1999, 83 p.
78. VYÖRYKKÄ, J., IITTI, H., VUORINEN, T., STENIUS, P., Confocal Raman microscopy in paper coating mapping analysis. Spectoscopy seminar: Raman and IR methods in paper industry. Espoo, 24.10.2002. Helsinki University of Technology, Laboratory of Forest Products Chemistry, Reports Series B7, Espoo 2002
79. GANE, P. A. C., KETTLE, J. P., MATTHEWS, G. P., RIDGWAY, C. J., Void space structure of compressible polymer spheres and consolidated calcium carbonate paper-coating formulations, Industrial and Engineering Chemistry Research, 35(5), 1996, p1753-1764
80. RIDGWAY, C. J., GANE, P. A. C., Bulk density measurement and coating porosity calculation for coated paper samples, Nordic Pulp and Papeper Research Journal vol. 18(2003)1, pp 24-31
81. SCHOELKOPF, J., GANE, P. A. C., RIDGWAY, C. J., MATTHEWS, G. P., Influence of Inertia on Liquid Absorption into Paper Coating Structures, Nordic Pulp and Paper Research Journal, 15(5), 2000, p422-430
82. GANE, P. A. C., SCHOELKOPF, J., SPIELMANN, D. C., MATTHEWS, G. P., RIDGWAY, C. J., Fluid transport into porous coating structures: some novel findings, Tappi Journal, 83(5), 2000, p77-78
83. SCHOELKOPF, J., Observation and modelling of fluid transport into porous paper coating structures, 2002, PhD Thesis, University of Plymouth, U.K.

84. RIDGWAY, C. J., SCHOELKOPF, J., GANE, P. A. C., A new method for measuring the liquid permeability of coated and uncoated papers and boards, Nordic Pulp and Paper Research Journal vol. 18(2003)4, p. 377-381
85. SCHOELKOPF, J., GANE, P. A. C., RIDGWAY, C. J., Observed non-linearity of Darcy permeability in compacted fine pigment structures, Symposium: In Memory of Dr. Bernie Miller, TRI Princeton, 2002
86. GANE, P. A. C., SEYLER, E. N., Tack development: an analysis of ink/paper interaction in offset printing, Tappi Coating Conference, San Diego, California, Tappi Press, Atlanta, 1994
87. Dimensioning and construction drawings of existing printing machines of MAN-Roland Druckmaschinen AG
88. URBAN, G., HAUSER, J. R., Design and Marketing of New Products, 2nd edition, Englewood Cliffs, New Jersey, Prentice-Hall, 1993, p. 78-501.

