

# An Arrangement to Locate and Identify People with Dual-Frequency Tags Providing Context-Related Information

---

Antti Ropponen



# An Arrangement to Locate and Identify People with Dual-Frequency Tags Providing Context-Related Information

**Antti Ropponen**

A doctoral dissertation completed for the degree of Doctor of Science (Technology) to be defended, with the permission of the Aalto University School of Electrical Engineering, at a public examination held at the lecture hall S1 of the school on 14 December 2012 at 12.

**Aalto University  
School of Electrical Engineering  
Department of Electronics  
Applied Electronics Research Group**

**Supervising professor**

Prof. Raimo Sepponen

**Thesis advisor**

Prof. Raimo Sepponen

**Preliminary examiners**

Prof. Lauri Sydänheimo, Tampere University of Technology, Finland

Prof. Manos M. Tentzeris, Georgia Institute of Technology, USA

**Opponents**

Prof. Jarmo Alander, University of Vaasa, Finland

D.Sc. (Tech.) Jukka Ruoskanen, Defence Forces Technical Research  
Centre, Finland

Aalto University publication series

**DOCTORAL DISSERTATIONS** 152/2012

© Antti Ropponen

ISBN 978-952-60-4870-3 (printed)

ISBN 978-952-60-4871-0 (pdf)

ISSN-L 1799-4934

ISSN 1799-4934 (printed)

ISSN 1799-4942 (pdf)

<http://urn.fi/URN:ISBN:978-952-60-4871-0>

Unigrafia Oy

Helsinki 2012

Finland



**Author**

Antti Ropponen

**Name of the doctoral dissertation**

An Arrangement to Locate and Identify People with Dual-Frequency Tags Providing Context-Related Information

**Publisher** School of Electrical Engineering**Unit** Department of Electronics**Series** Aalto University publication series DOCTORAL DISSERTATIONS 152/2012**Field of research** Applied Electronics**Manuscript submitted** 16 April 2012**Date of the defence** 14 December 2012**Permission to publish granted (date)** 17 August 2012**Language** English **Monograph** **Article dissertation (summary + original articles)****Abstract**

The demographic dependency ratio is changing in the industrialized countries, because the proportion of senior citizens is growing. An electric sensor with intelligence (ELSI) system was developed to monitor and locate patients, which helps the caring personnel and upgrades the service. The system has been used in many care homes for the elderly in Finland and has proved its benefits for the patients and staff.

The problem with the ELSI system was that it could not identify the people it located. Additionally, the alarm devices that were used were impractical. Hence a dual-band localization system was introduced to address these deficiencies.

The dual-band system uses active tags that are located with an antenna matrix embedded into the ELSI floor. The tag communicates with the ELSI system using a ZigBee network. The tag also has a display, and thus it can be used to show short alarms. Furthermore, an outline of a more versatile alarm and information system is introduced, with a multifunctional name tag concept.

The system introduced here was demonstrated with a pilot installation which consisted of the ELSI and the dual-band system. It was shown that the system can locate and identify people with an accuracy of  $0.64 \text{ m} \pm 0.31 \text{ m}$  (S.D.). The accuracy can even be improved if the data are combined with the ELSI localization information. It was also shown with measurements that the localization method can be considered to be robust, because the LF signal penetrates nearly all normal objects.

**Keywords** indoor tracking, radio frequency identification, near field imaging, low-frequency, ZigBee, elder care

**ISBN (printed)** 978-952-60-4870-3**ISBN (pdf)** 978-952-60-4871-0**ISSN-L** 1799-4934**ISSN (printed)** 1799-4934**ISSN (pdf)** 1799-4942**Location of publisher** Espoo**Location of printing** Helsinki**Year** 2012**Pages** 132**urn** <http://urn.fi/URN:ISBN:978-952-60-4871-0>



**Tekijä**

Antti Ropponen

**Väitöskirjan nimi**

Kontekstipohjaiseen dataan perustuva järjestely ihmisten tunnistamiseen ja paikantamiseen kaksitaajuustunnisteella

**Julkaisija** Sähkötekniikan korkeakoulu**Yksikkö** Elektroniikan laitos**Sarja** Aalto University publication series DOCTORAL DISSERTATIONS 152/2012**Tutkimusala** Sovellettu elektroniikka**Käsikirjoituksen pvm** 16.04.2012**Väitöspäivä** 14.12.2012**Julkaisuluvan myöntämispäivä** 17.08.2012 **Kieli** Englanti **Monografia** **Yhdistelmäväitöskirja (yhteenveto-osa + erillisartikkelit)****Tiivistelmä**

Teollisuusmaiden huoltosuhde on muuttumassa, koska vanhusten lukumäärä suhteessa muuhun väestöön kasvaa. Electric sensor with intelligence (ELSI) järjestelmä kehitettiin valvomaan ja paikantamaan potilaita, mikä helpottaa hoitohenkilökunnan työtä, sekä auttaa parantamaan annettua palvelua. Järjestelmää on käytetty useassa vanhainkodissa Suomessa ja se pienentää todistettavasti henkilökunnan työtaakkaa.

ELSI järjestelmän ongelmana oli, ettei se pysty identifioimaan paikantamiaan ihmisiä. Lisäksi järjestelmään liitetyt hälytysjärjestelmät olivat epäkäytännöllisiä. Näitä puutteita korjatakseen esiteltiin kahta taajuutta käyttävä paikannusjärjestelmä.

Kaksitaajuusjärjestelmä käyttää aktiivisia tunnisteita, joita paikannetaan ELSI lattiaan liitetyillä antennilla. Tunniste kommunikoi edelleen ELSI järjestelmän kanssa ZigBee verkon välityksellä. Tunnisteessa on myös näyttö, jolle voidaan tulostaa erilaisia hälytyksiä. Tunnisteesta esiteltiin myös monikäyttöinen konseptiversio, jossa erilaista informaatiota näytetään nimikyltillä.

Esitellyn kaksitaajuusjärjestelmän toimintaa esiteltiin ja testattiin yhdessä ELSI järjestelmän kanssa. Järjestelmä pystyy tunnistamaan henkilön ja paikantamaan hänet 0.64 m tarkkuudella 0.31 m:n keskihajonnalla. Paikannustarkkuutta voidaan parantaa edelleen liittämällä kaksitaajuusjärjestelmän paikannusinformaatio ELSI järjestelmän tuottamaan paikannusinformaatioon. Käytetty matala taajuus pystyy läpäisemään lähes kaikki normaalit esineet, joten paikannukseen ei synny helposti katveita.

**Avainsanat** sisätalapaikannus, radiotaajuinen etätunnistus, lähikenttäkuvantaminen, matalataajuisuus, ZigBee, vanhustenhuolto

**ISBN (painettu)** 978-952-60-4870-3**ISBN (pdf)** 978-952-60-4871-0**ISSN-L** 1799-4934**ISSN (painettu)** 1799-4934**ISSN (pdf)** 1799-4942**Julkaisupaikka** Espoo**Painopaikka** Helsinki**Vuosi** 2012**Sivumäärä** 132**urn** <http://urn.fi/URN:ISBN:978-952-60-4871-0>





# Preface

This work was carried out at the Department of Electronics in Aalto University's School of Electrical Engineering during the years 2007-2011. I am most grateful to Raimo Sepponen, the head of the department, for giving me the opportunity to study this research topic. I appreciate his leadership and all the help he has given me during the research. I thank him for being the instructor and the supervisor of this thesis.

I also thank Matti Linnavuo and Henry Rimminen for their co-authorship and help during the research. Matti has been a great help in reviewing and writing the papers. Henry's help was irreplaceable when the RFID system was embedded into the ELSI system.

I also have to give special thanks to all the people in Applied Electronics. The supportive atmosphere has been something I will always remember. Thank you, Antti, Kim, Lauri, Jori, Mikko, and Ganesan.

My wife Elsa did not help me with the technical issues, but I have to thank her for all the other kinds of support she gave. She has been the practical thinker in the family, while I have been writing this thesis and wandering around.. I also thank our children, Ronja and Oliver, for bringing me back down to earth.

This study has been supported by the Jenny and Antti Wihuri Foundation, Aalto University's School of Electrical Engineering, and the Finnish Society of Electronics Engineers.

Antti Ropponen  
Helsinki, 2012

# Contents

- Preface.....1
- Contents ..... 2
- List of publications ..... 4
- Author’s contribution ..... 5
  - Author’s contributions to the publications..... 5
  - Author’s contribution to the technology..... 5
- Abbreviations..... 7
- 1 Introduction ..... 7
  - 1.1 Background ..... 8
  - 1.2 Passive localization methods and the ELSI system..... 9
    - 1.2.1 Passive methods ..... 9
    - 1.2.2 ELSI system ..... 10
  - 1.3 Active localization methods ..... 11
    - 1.3.1 Triangulation..... 11
    - 1.3.2 Fingerprinting ..... 12
    - 1.3.3 Proximity .....13
  - 1.4 A scenario to describe the functionalities of the possible system..... 14
  - 1.5 Localization tag ..... 16
  - 1.6 Name tag approach ..... 16
  - 1.7 Multifunctional tags in systems with context-based services ..... 18
  - 1.8 Goals of the study.....20
- 2 Materials and Methods ..... 21
  - 2.1 Dual-band RFID localization method ..... 21

2.2	LF scanning.....	24
2.3	Combining ELSI and RFID information .....	25
2.4	Sensor and antenna .....	27
2.5	MUX units.....	28
3	The infrastructure that was designed.....	29
3.1	New laminate structure .....	29
3.2	New MUX unit .....	30
3.3	The tag that was designed.....	31
3.4	The pilot system that was built.....	32
4	Results.....	35
4.1	Magnetic field of the LF transmitter .....	35
4.2	Read range and signal penetration.....	35
4.3	Identification speed .....	37
4.4	Localization accuracy of the RFID system .....	38
4.5	Discrimination performance .....	38
4.6	Demonstration of the name tag concept .....	40
5	Discussion .....	41
5.1	Localization accuracy.....	41
5.2	Read range and penetration .....	42
5.3	Combining the RFID and ELSI information .....	42
5.4	Multifunctional user interface and RFID tag .....	43
5.5	Improvements to the design.....	44
6	Conclusions.....	46
	References .....	48

# List of publications

This thesis consists of this summary and the following articles, which are referred to in the text by their symbols ([P1] to [P5]).

- P[1] A. Ropponen, M. Linnavuo, & R. Sepponen, 2009. LF Indoor Location and Identification System. *International Journal on Smart Sensing and Intelligent Systems*, vol. 2, no. 1, pp. 94-117.
- P[2] A. Ropponen, M. Linnavuo, & R. Sepponen, 2011. Low-Frequency Localization and Identification System with ZigBee Network. *International Journal on Smart Sensing and Intelligent Systems*, vol. 4, no. 1, pp. 75-93.
- P[3] A. Ropponen, H. Rimminen, & R. Sepponen, 2010. Robust system for indoor localization and identification for the healthcare environment, *Wireless Personal Communications*, vol. 59, no. 1, pp. 57-71.
- P[4] A. Ropponen, H. Rimminen, & R. Sepponen, 2011. Active Low-Frequency Localization System Used With Passive Near Field Imaging, *International Journal on Communications Antenna and Propagation*, vol. 1, no. 2, pp. 152-157.
- P[5] A. Ropponen, M. Linnavuo, & R. Sepponen, A Novel Concept of a Wearable Information Appliance Using Context-based Human-computer Interaction, *Personal and Ubiquitous Computing*, Online First™, 19 November 2011, Paper version to be published.

# Author's contribution

## **Author's contributions to the publications**

The results introduced here have been achieved in a research team. The author had the main responsibility for the design and implementation of the system.

Publication I presents the basic concepts of the low-frequency localization. The author is the first author and is responsible for the design and implementation of the tag electronics and test arrangements. He also wrote most of the article.

Publication II presents the first functioning prototype of the dual-frequency localization system. The paper illustrates the electronics that were developed and measurements of the system. The author was the first author and was responsible for the development of the tag that was used and the test arrangements. He also wrote most of the article.

Publication III presents a new laminate and multiplexer structure for the low-frequency system and related measurements. The author was the first author. The author was responsible for designing the operational principle of the laminate and the multiplexers. He designed and implemented the tests together with Henry Rimminen, who is the second author. The author also wrote most of the article.

Publication IV presents a way to use the passive ELSI system to improve the localization accuracy of the LF system. The author was the corresponding author and he designed and implemented the localization algorithms. The test arrangements were designed together with Henry Rimminen, who was the second author. The author also wrote most of the article.

Publication V presents a novel way to show context-related data with a multifunctional identification tag. The author was the first author and was responsible for designing and implementing the concept. He also wrote most of the article.

## **Author's contribution to the technology**

The system and the thesis are a continuation of the technology that was introduced in the author's Master's thesis [1]. The idea and the basic concept of RFID localization were conceived by Professor Raimo Sepponen,

the supervisor of the thesis. Passive ELSI localization systems with multiplexers, laminate, and other electronics existed and were in use when the construction of the LF system started.

The author's main responsibility was to design and implement a tag that could be located with loop antennas that were placed on the ELSI laminate. The tag should also be able to enable various kinds of context-based services to be provided. Two of the tags that were developed are illustrated in publications I and II. The existing infrastructure of the ELSI system proved to be partly insufficient for use with RFID localization. Hence the author also designed some upgrades for the ELSI infrastructure that can be seen in publication III and the pending patent [2]. The author designed and implemented the nearest cell localization algorithm for the existing ELSI software (Publication IV). The author also designed the concept of using a name tag as a multifunctional user interface device (see publication V and the pending patent [3]).

# Abbreviations

AA	active area
CAN	controller area network
DC	direct current
ELSI	electric sensor with intelligence
EPD	electrophoretic display
ERC	European Radiocommunications Committee
GPS	global positioning system
HF	high-frequency
LF	low-frequency
MUX	multiplexer
NCL	nearest cell localization
NNDA	nearest neighbor discriminant analysis
NFI	near field imaging
PDA	personal digital assistant
RFID	radio frequency identification
RSSI	received signal strength identification
SMS	short message service
TOF	time-of-flight
USB	universal serial bus
WLAN	wireless local area network

# 1. Introduction

## 1.1 Background

The demographic dependency ratio is changing in the industrialized countries, because the proportion of senior citizens is growing [4]. Additionally, because of the rising living standards and improved medical care, it has been estimated that the number of people aged 60 or more is set to quadruple globally by the year 2050 [5]. This will generate stress for healthcare systems, that is, how to take care of all the senior citizens. To upgrade the services provided to the customers, some automation is needed. The “ELectric Sensor with Intelligence” (ELSI) system was created at the Department of Electronics of Helsinki University of Technology in order to add a localization service for the elderly and healthcare. The ELSI system is based on the use of near field imaging (NFI) to track people. The people to be located do not have to carry any kind of a transponder.

The ELSI system uses spatially modulated electric fields to detect the presence, movement, falls, and biosignals of people [6]. The ELSI system has proved its benefits in the environment of care for the elderly and it has been used in several care homes for the elderly in Finland. It detects, for example, residents falling, entering the toilet, getting out of bed, and exiting rooms [7]. This kind of monitoring helps the nursing staff in their daily work and reduces the stress level [8]. The ELSI system is also a good platform for various interactive applications [9].

Even though the ELSI system is beneficial in many ways, it also has some weaknesses. Because the system measures only electrical parameters from the human body, it cannot identify people. This leads to a problem, for example, in situations when it is necessary to know if a patient or a nurse has left the room being monitored. Identification together with localization is also vital to devise some individual services [19].

One reported solution for identification is the use of active capacitive RFID tags [10]. The system was quite reliable in identifying people. However, the demonstration system was uncomfortable to use, because the tag had to be installed inside the user’s shoes in order for there to be capacitive contact with the NFI sensors. During the tests, the tags chafed



the users' feet and therefore they could use them only for short periods. This problem may be solved by the better design of the shoes with the tags.

Another problem with the pilot ELSI system at the Kustaankartano home for the elderly was that the communication medium in alarm situations was mobile phones' text message services (SMS) [7]. The use of mobile phones was impractical because the device is not designed for alarm purposes and because of the high cost of SMS messaging.

Location information has been used in the healthcare environment to ascertain where certain people and items are [11, 12]. However, more versatile systems could be implemented if the location information is combined with context-aware solutions. For example, when a nurse arrives beside the bed of a patient, the system receives the location data and sends the patient's records to his/her mobile device, as in mobile tour guide systems that operate in a similar way [13, 14].

Automatically operating systems create a challenge for mobile devices. The problem is how to show the data to the staff and how to keep a large amount of information available while keeping the device easy to use. Mobile devices, such as personal digital assistants (PDA) and mobile phones, have been used to show important information for medical care, for example patient data and drug lists [15, 16, 17, 18]. However, PDAs' and mobile phones' user interfaces have complex menu structures that are cumbersome to use [19, 20]. Hence a separate device that is designed for healthcare purposes is needed.

## **1.2 Passive localization methods and the ELSI system**

### **1.2.1 Passive methods**

While active localization methods track specific transponders, the passive ones are based on the properties of objects that are tracked. Passive systems may locate people with cameras [21, 22] or with sensors measuring either the weight distribution [23, 24, 25] or electric coupling of the human body [26, 27, 28, 29]. The advantage of the passive systems is that they produce rather accurate location estimates (18 cm-41 cm) [22, 29, 30]. However, identification with passive systems is not straightforward. Early face recognition systems had difficulties with identifying people from different angles or in crowded situations [31, 32]. Remote biometric identification systems need a burdensome learning process [23, 24, 33].

### 1.2.2 ELSI system

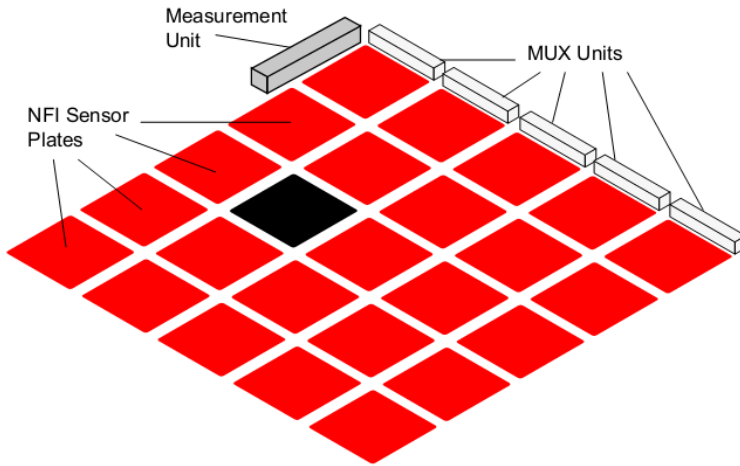
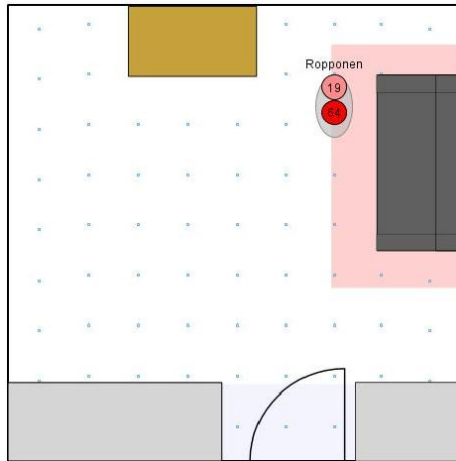

**Fig. 1** ELSI system. The measurement unit creates the low-frequency signals and transmits them to the sensor plate (black square) using the MUX units. Then it measures the current between the sensor and grounded plates (red squares).

The ELSI system uses a sensor matrix placed under the floor covering to track people (Fig. 1). A low-frequency, low-voltage signal is fed to each sensor at a time while the others are coupled to ground. If a human body is near the active sensor, it affects the impedance between the sensor and grounded elements and thus the current in the loop. When that change in the current is detected, e.g., people can be located. The method is an application of near field imaging (NFI) because it relies on near field coupling between the sensor matrix and the object to be located.

The ELSI system, like passive localization systems in general, is rather accurate. The demonstrated tracking error of the system is 21 cm with a standard deviation of 13 cm. When two or more people are in the same room, the system can separate them in 99% of cases if the distance between them is over 110 cm [34].

The software of the ELSI system creates localization cells from the observations [34]. Fig. 2 shows how two observations (red circles) are linked to one localization cell (gray oval). Because the cells are software objects, they may have many different parameters, for example, lifetime, and in the case of the figure, the identification (Ropponen).



**Fig. 2** Localization cell with identification (Ropponen) and the active areas. The localization cell is shown as a gray oval, the active areas as red and blue rectangles.<sup>1</sup>

The ELSI software maps the service area. The software can outline smaller active areas (AA) to produce signals when someone arrives there (Fig. 2, blue and red rectangles). These areas may be used to invoke alarms, for example when the person gets out of the bed or is going to exit the room [7].

### 1.3 Active localization methods

Active localization methods are used to track devices with different wireless media, for example radio frequency (RF) signals [35, 36, 37], visible light [38], infrared [39], or ultrasound [40, 41, 42, 43, 44]. These kinds of systems have been developed because the GPS signal is not always available inside buildings [45]. Active methods may be categorized according to the localization type used: triangulation, fingerprinting, or proximity [46].

#### 1.3.1 Triangulation

In triangulation, a location is calculated by using the transponder's distance or angle of arrival from at least three reference points [46]. The distance can be measured using time-of-flight (TOF), received signal strength indication (RSSI), or a combination of both.

The advantage of triangulation is that an already-built wireless infrastructure, for example ZigBee, Bluetooth, or wireless local area networks (WLAN), can be used to build a localization system. However, the reported localization accuracy with these systems may not be enough for care applications [35, 36].

An ultrasound system can locate the tags with an error of less than 10 centimeters [40, 43]. However, a dense matrix of receivers is needed to

---

<sup>1</sup> Published in Personal and Ubiquitous Computing, Online First™, 19 November 2011.

achieve such a performance. For example, the Active Bat system uses 720 receivers to cover an area of 1000m<sup>2</sup> [44]. Clothes attenuate the ultrasound signals [47], and therefore the tags have to be carried so that they are on the clothing.

### 1.3.2 Fingerprinting

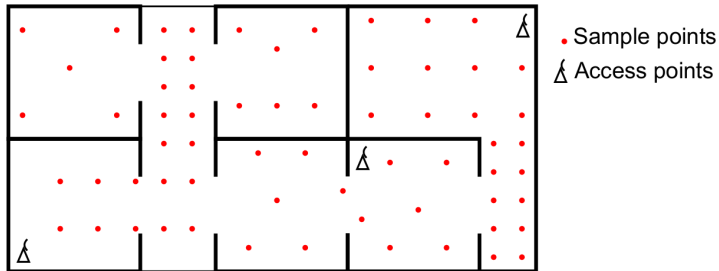

**Fig. 3** Fingerprinting. Red dots are measured sample points, antennas mark the access points.

Fingerprinting is a two-step localization method. First a reference map is created, which consists of sample points (Fig. 3). At every sample point the system measures with access points a “fingerprint” using RSSI. Then, when the system is turned on, the location can be calculated by comparing the new measured data to the fingerprints [48, 49]. Fingerprinting may also be used with WLAN networks. Triangulation in the 2.4-GHz band suffers from multipath propagation in the indoor environment, which reduces the localization accuracy [50]. Fingerprinting resolves the problem because it is known how the waves propagate in fixed spots [51]. However, the mapping is burdensome. Additionally, the comparison between the measured value and the fingerprints takes time and computing power. Hence the fingerprint systems are suitable for small areas [51].

### 1.3.3 Proximity

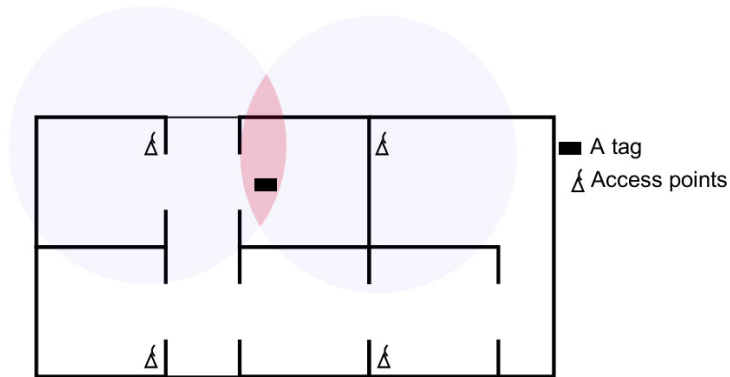
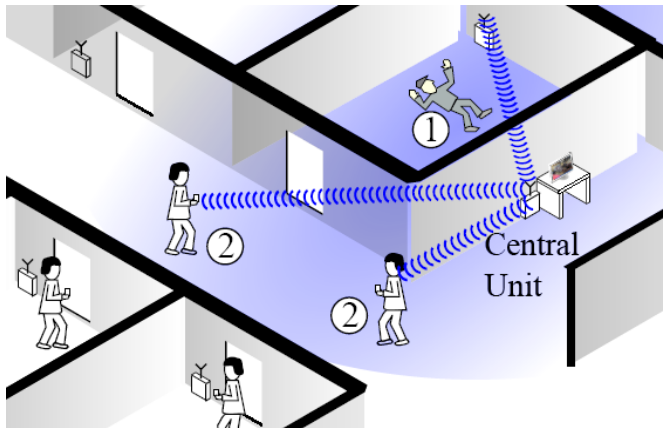

**Fig. 4** Proximity. A tag is in the coverage area of two access points. The red area indicates the region where the tag is known to be located.

Proximity systems sort out which transmitter's coverage area the transponder is in, and thus it can be said that proximity is a binary quantization of the RSSI [52]. Hence, the larger the coverage area is, the greater the tracking error. However, the error can be reduced by combining the localization data from different transmitters, if the coverage areas overlap (Fig. 4).

For example, the LANDMARC and NearMe systems use proximity for the localization [53, 54]. In the indoor environment RF signals penetrate the walls and thus the coverage areas have to be kept small, if it is desired to know if someone is in a specific room. With ultrasound transmitters or visible light it can be assured that someone is in the room because the signals cannot penetrate the walls [38,40].

## 1.4 A scenario to describe the functionalities of the possible system



**Fig. 5** System scenario. A patient has fallen and the ELSI system notices it (1). The central unit transmits an alarm to the nearest nurses (2).<sup>2</sup>

In an example scenario (Fig. 5), a patient has fallen (1). The ELSI system perceives the fall and transmits an alarm to the central unit. The central unit knows the location of the nurses and transmits the alarm to the people who are nearest to the room from which the alarm was sent (2). The nurses receive the alarm with a wireless identification tag.

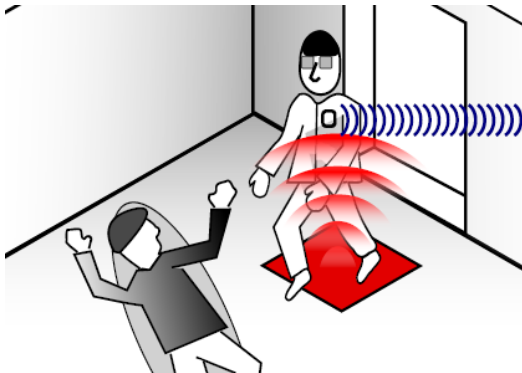

**Fig. 6** The NFI system detects an incoming nurse (red square) and launches the RFID scan (red curves).<sup>3</sup>

---

<sup>2</sup> Published in the International Journal on Communications Antenna and Propagation (IRECAP), Vol. 1 No. 2, 2011. Quoted with the permission of the publisher, Praise Worthy Prize S. r. l. <http://www.praiseworthyprize.com/>; [info@praiseworthyprize.com](mailto:info@praiseworthyprize.com), p. 153.

When a nurse arrives in the room, the NFI system perceives him/her (red square) and launches the RFID scan (red curves) (Fig. 6). The tag receives the localization information and transmits the location data and nurse's identification back to the central unit (blue curves), which indicates that the patient has been taken care of. Then, when the central unit gets the information that the nurse is in patient X's room, the system transmits his/her records to the tag automatically (Fig. 7). In this way, the nurse gets even the most recent information on the patient, (drugs, diseases, recent accidents etc.), that might help to solve what has happened to him/her. With the tag, the nurse can also transmit requests for help if the situation is critical.

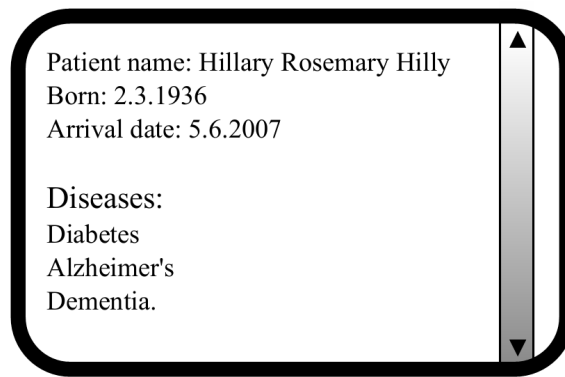

Fig. 7 The patient record appears on the tag's screen automatically. <sup>4</sup>

---

<sup>3</sup> Published in the International Journal on Smart Sensing and Intelligent Systems, vol. 4, no. 1, p 78.

<sup>4</sup> Published in Personal and Ubiquitous Computing, Online First™, 19 November 2011.

## 1.5 Localization tag



**Fig. 8** Outline of a simple localization tag. The tag includes a couple of buttons and a screen for communication.

A tag that could be tracked and identified using some of the ELSI infrastructure was needed to fulfill some of the requirements that the system scenario in Section 1.4 assumes. The tag should have buttons and a display device to demonstrate some alarm functionalities (Fig. 8, Table 1). With this stripped-down tag it would be able to pilot localization performance and test different wireless communication mediums. This would give essential information on how to build a multifunctional tag.

**Table 1** Functionalities demanded for the stripped-down tag

<b>Demand</b>	<b>Solution</b>
User interface	Buttons and display
Communication	Wireless network
Localization	Wireless network

## 1.6 Name tag approach

If there is a new localization device, careful consideration must be given to where it is carried. In the healthcare environment, doctors and nurses have many things to carry with them in their pockets, for example medical instruments and a mobile phone. For hygiene reasons, anything worn on the wrist should be avoided [55].



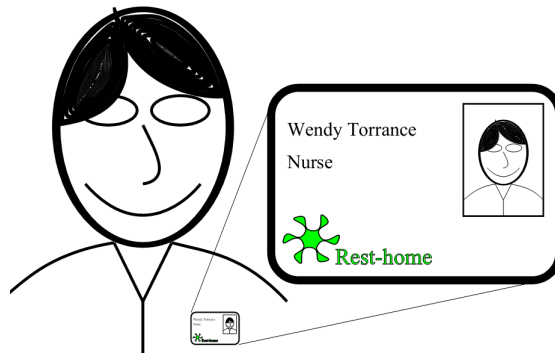

Fig. 9 The tag acts as a name label.<sup>5</sup>

The novel approach is that the name tag which is normally carried by the employees acts as a multifunctional tag (Fig. 9). In a normal situation, the tag just shows the doctor's or the nurse's personal data. But, depending on the context, the display changes to show essential information, for example patient records (Fig. 7), door-opening buttons (Fig. 30), or alarms. Because the tag replaces an existing name label, no additional device would be carried [3] (Fig. 10).

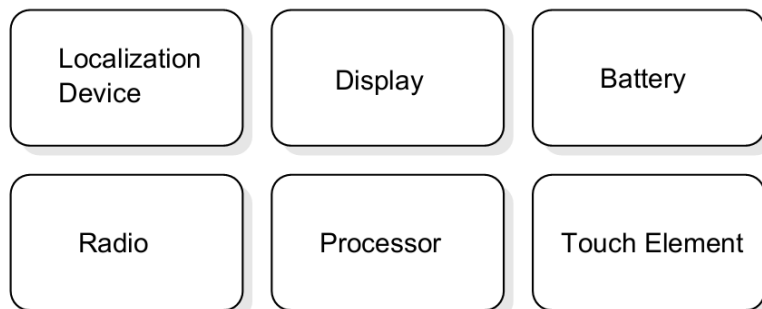

Fig. 10 The name tag's functional blocks.

Naturally, if a display is used as a name label, it always has to be on. To keep power consumption at a realistic level a microencapsulated electrophoretic display (EPD) [56] has to be used. EPD or electric paper consumes power only when the picture on the display is changed. The technology is widely used nowadays, for example in e-books (Kindle®, Sony® Reader Digital Book). The motionless black-and-white EPD is a mature technology, but displays which can show videos [57] and even color displays have also been developed [58].

---

<sup>5</sup> Published in Personal and Ubiquitous Computing, Online First™, 19 November 2011.

The system may handle confidential patient data. That is why these tags may have to be secured with a personal security code. The data in the network must also be encrypted in order to maintain data confidentiality and integrity [59].

### 1.7 Multifunctional tags in systems with context-based services

The location-aware multifunctional tag could be used for various purposes. When the location of the tag is known it can react in a way that depends on the context. In the system scenario (1.4) the tag changes its display to show patient records. The identification may be used to access control [60]. With the user interface, the authentication buttons may also be shown and used (Fig. 11). The location information could be used to automatically fill task lists [61], for example to record the patients the nurse has visited and when these visits have taken place. The tag may also be able to receive alarms and could be used to acknowledge them (Fig. 11) [P5].

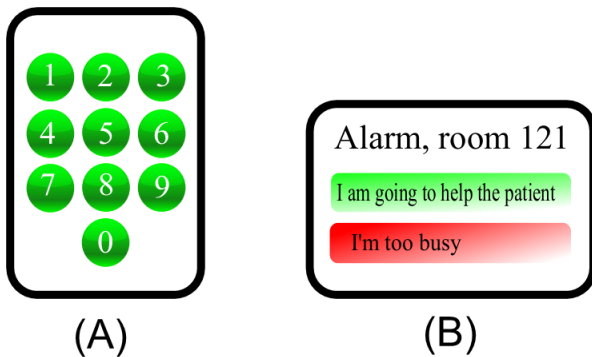

Fig. 11 The interface of a multifunctional tag may serve as a keyboard for the input of an authentication code (A) and acknowledgement of alarms (B).<sup>6</sup>

It would be feasible to use the multifunctional tags in systems which include necessary databases for context-based services [62]. If the hospital data were stored in the tags, the updating would totally congest the network. It would also force a tag to be more complex (and more expensive) because of data storage devices.

The data should be stored in different servers. In this way, the system is easier to sustain and more secure than with one giant server [63, 64]. For example, this context-based system should have at least three different servers. The first one would contain the ELSI and RFID information, identification data, NFI cells, active areas etc. This server would awaken the other databases that include all the service-related information (Fig.12).

---

<sup>6</sup> Published in Personal and Ubiquitous Computing, Online First™, 19 November 2011,

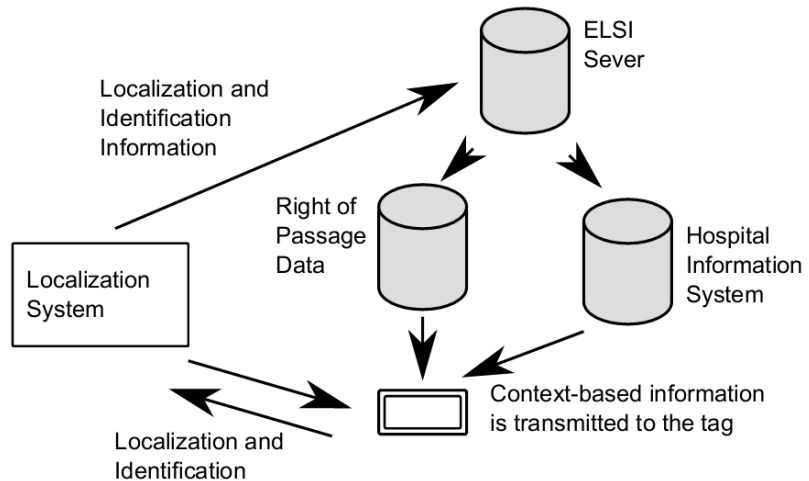

**Fig. 12** The localization system locates and identifies the tags and transmits the data to the ELSI server.

The two other servers would include the hospital information and security information. For example, when an identified person arrives at a door, the ELSI server informs the security server, which then decides if the door will open. In the same way, the hospital data are transmitted to the tag if a nurse arrives at a patient's bed (Fig. 12).

To build a system that can handle everything in the situation that was described in Section 1.4, new infrastructure was needed around the ELSI system. The main thing was to develop a tag which can be located and identified and which can also show the context-based information. Rodriguez, Favela, Martinez, and Muñoz list three major things that should be accessed with a handheld device in a hospital environment [65]. A device should be able to show patient records, laboratory results, etc., the location of patients and colleagues, and the location of medical equipment, beds, etc.

To support the ELSI system and benefit from its strengths, a device that could be located using mainly the same infrastructure should be created. The device should be able to receive alarms and provide an interface to respond to them. The additional localization and alarm infrastructure should also provide a platform for different applications and context-based services.

## **1.8 Goals of the study**

This study has the following goals:

- 1) to create an active localization and identification system which can be integrated into the existing passive system;
- 2) to create a system in which location information from the passive system is used to improve the localization accuracy of an active localization system;
- 3) to create a platform for various kinds of applications and context-based services;
- 4) to demonstrate the operation of the system thus devised in a laboratory environment.

## 2. Materials and Methods

### 2.1 Dual-band RFID localization method

Proximity was selected to be the localization method of the RFID system; the ELSI laminate included loop antennas that could be used for the localization [P1]. The transmission system could then be created with almost no extra infrastructure. When the ELSI system is used it is very cheap to add the RFID capability. Both the systems use the same laminate and, partially, the same electronics [P1-P4].

A low-frequency signal was used because of the wiring properties of the sensor elements. Signal wires cannot be shielded and they can be up to 7 meters long. To reduce reflections and power losses on the transmission line the carrier frequency should stay below 430 kHz [P1]. Carrier frequencies from 100 kHz to 125 kHz were selected because of the availability of suitable receiver chips and the frequency band was allocated for near field communication and RFID use [83][P1].

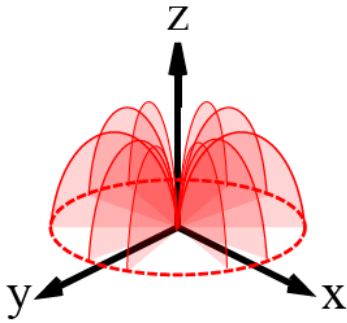

**Fig. 13** Theoretical radiation pattern of a small loop antenna in a free space. The antenna is on the XY-plane. The pattern is the same towards the  $-Z$  axis.<sup>7</sup>

Because of the low frequency, the antenna is relatively small compared to the wavelength and thus the theoretical field pattern of a single loop antenna is almost a sphere in free space (Fig. 13) [66]. This means that if the vertical read range is increased with a higher current, the horizontal range becomes correspondingly wider [67], which reduces the localization accuracy of the system [P1]. The near field region of the antenna is  $\lambda/2\pi$  m away from the antenna plane [68]. With the 100-125-kHz carrier frequency that was used ( $\lambda \approx 2,5$  km), the near field extends to almost 400 m away from the antenna. The small coil antenna's wave impedance  $Z$  in the near field at the distance  $r$  can be calculated using Equation 1:

$$Z \approx 240\pi^2 \frac{r}{\lambda} \quad [1]$$

The magnetic field  $H$  can be calculated from the electric field  $E$  using Equation 2:

$$Z = \frac{E}{H} \quad [2]$$

Material's skin depth  $\delta$  can be calculated with Equation 3 [69]:

$$\delta = \sqrt{\frac{2}{\omega\mu\sigma}} \quad [3]$$

where  $\omega$  is the radian frequency,  $\mu$  is the conductor magnetic permeability ( $\mu = \mu_0 = 1.26 \times 10^{-6}$  Vs/(Am)), and  $\sigma$  the material's bulk conductivity. When the transmitted wave confronts a material orthogonally, the signal attenuates as:

$$-20 \log \left( \frac{1}{e} \right)^{\frac{t}{\delta}} \quad [4]$$

where  $\delta$  is the skin depth and  $t$  the thickness of the material [P3].

---

<sup>7</sup> Published in the International Journal on Smart Sensing and Intelligent Systems, vol. 2, no. 1, p. 100.

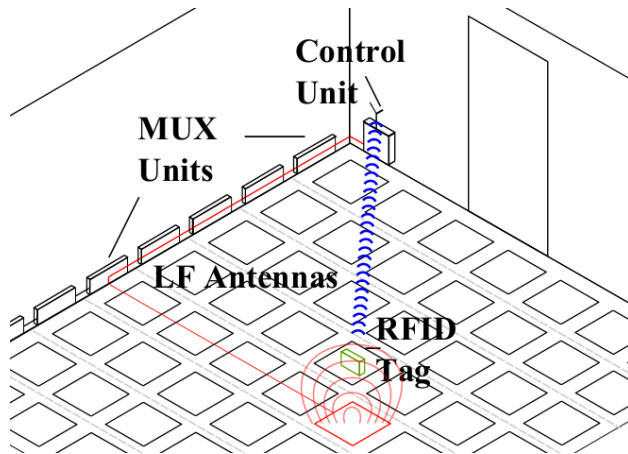
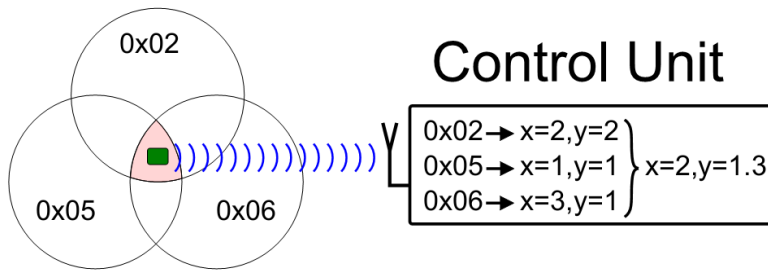

**Fig. 14** Dual-signal localization with loop antenna matrix <sup>8</sup>

In the system, a matrix of loop antennas is placed under the floor covering. Every antenna transmits an LF signal, modulated with a location code, in a sequence. If a tag is in the read range of the antenna, it detects the LF signal, decodes it, and sends decoded information back to the system with the tag's ID code (Fig. 14) [P1].

---

<sup>8</sup> Published in the International Journal on Smart Sensing and Intelligent Systems, vol. 2, no. 1, p. 98.



**Fig. 15** The control unit calculates a centroid from the received localization values.

Each location code has corresponding coordinate information in the control unit. The control unit translates the codes (0x02, 0x05, 0x06) to the coordinates and calculates a centroid which is the estimated location of the tag (Fig. 15). The location codes and identification information were sent back to the system with a ZigBee radio (2.4 GHz) [P1, P2].

## 2.2 LF scanning

An obvious way to localize people with the antenna matrix is to transmit the LF signal to every antenna, receive and transmit them back with a tag, and calculate the location. The problem with this scanning is that the LF fields are almost as wide as they are high. Hence the LF signal might be received from the other side of the room, which naturally degrades the localization performance. With the initial localization system, the measured localization accuracy was only 1.1 m, with a standard deviation of 0.5 m [P2]. To improve the accuracy, a nearest cell localization (NCL) method was created [P4].



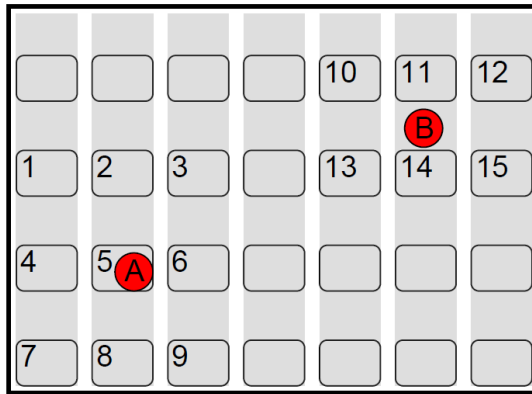

**Fig. 16** Nearest cell localization method. Only the neighboring antennas (1-9 and 10-15) to the related NFI cells A and B are activated.

NCL uses both the ELSI system and the RFID system to locate persons with the tags. When the ELSI system perceives someone on the floor it activates only the nearest LF antennas to the NFI cell. As can be seen in Fig. 16, antennas 1-9 are activated after NFI observation A and antennas 10-15 after observation B. When only the neighboring antennas are transmitting, the tag does not receive signals from remote locations in the room, which improves the localization accuracy and the identification performance of the RFID system. NCL also improves the speed of the system. There may be up to 128 antennas in the service area, and thus it is much faster to transmit the LF only to 6-9 antennas at a time (Fig. 16) than to all of them [P4].

### 2.3 Combining ELSI and RFID information

For the highest localization performance with identification that the whole system can offer, the ELSI localization data should be combined with RFID localization and identification information. If only one person is in the service area, it is easy to give the single RFID identification to the only NFI cell (Fig. 2, page 5). However, if there are two or more persons, it is harder to know which identification belongs to which cell. For example, the ELSI system discriminates between two people reliably if the distance between them is over 110 cm [34], which is almost the tracking error of the RFID system [P4].

When the identification is added to the ELSI system, the RFID localization data are used just to connect the right ID to the right cell. There are two ways to do that [P4]:

1. start randomly from one RFID data packet and combine it with the nearest cell, and continue further;
2. use nearest neighbor discriminant analysis (NNDA).

The first one is the easiest to implement, but it does not always give the best result, for example, in the case in Fig. 17, where in the real situation ID1 belongs to cell 1 and ID2 to cell 2. If combining is started from ID1, it connects itself with NFI cell 2, because it is the nearest one. Then ID2 does not have any option but to connect itself to NFI cell 1 (Fig. 18).

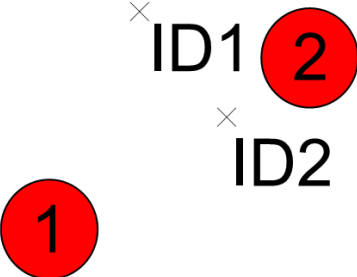
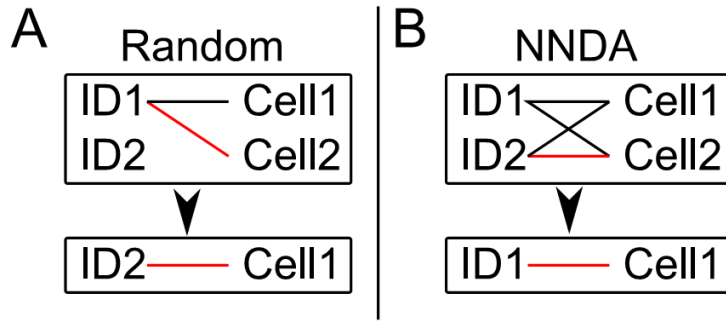

Fig. 17 Connecting RFID localizations (x) to NFI cells (red circles).

In NNDA, distance vectors from all RFID location estimates to every NFI cell are first calculated. Then the pair with the shortest distance is combined and the values are taken away from the tables. After that, the same thing is repeated until the tables are empty. In the Fig. 17 case, the shortest distance would have been ID2 and NFI cell 2 and the identification would have been correct (Fig. 18). So in this example case, the different algorithms produce different results because ID1 is so close to Cell2.



**Fig. 18** Function of randomly started combining and NNDA. Red line marks the selected pair.

## 2.4 Sensor and antenna

All the ELSI elements, RFID antennas, and wirings are printed on a thin plastic foil. In the first prototype, the laminate was two-layered. The signal wires were in the center row of the laminate and the connections to the antennas and ELSI elements crossed them on another layer. The two layers were connected with laser windings (Fig. 19). This two-layer structure was fragile and expensive to construct. The structure forced the laminate to have a discontinuous layout. If the laminate was cut, the rest of it went to waste. Additionally, the wirings took too much space from the ELSI elements, which worsened the performance of the system [P2, P3].

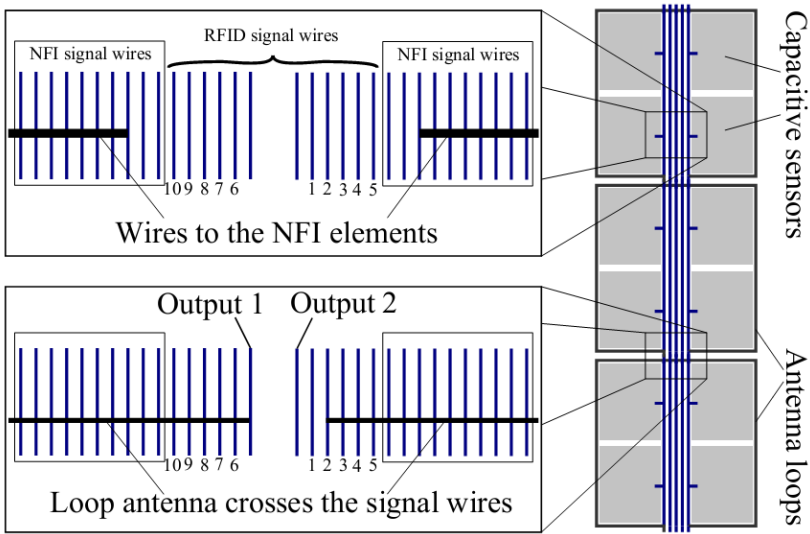

**Fig. 19** The two-layer structure of the ELSI laminate. It proved to be rather unreliable. The signal wires for the NFI and RFID signals crossed each other.<sup>9</sup>

## 2.5 MUX units

The old MUX units were designed for the old ELSI laminate (Fig. 1, Fig. 19) and could not supply transmitting currents higher than  $30 \text{ mA}_{\text{RMS}}$  as a result of the properties of the ADG706 multiplexers that were used (Analog Devices, Inc., MA, USA) [70]. Because of the small transmission current, the coverage volume of one antenna reached an altitude of only 1.78 meters at best [P2]. However, a receive height of at least two meters was needed to build a robust identification system, and thus new MUX units were needed [P3].

<sup>9</sup> Published in the International Journal on Smart Sensing and Intelligent Systems, vol. 4, no. 1, p 88.

### 3. The infrastructure that was designed

#### 3.1 New laminate structure

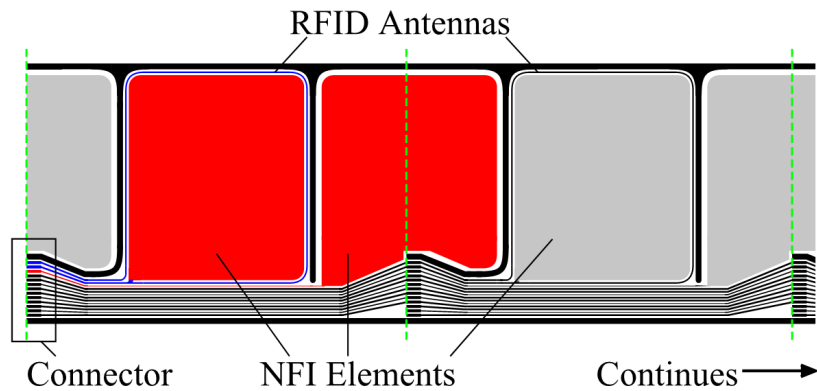

Fig. 20 Layout of the laminate that was designed.<sup>10</sup>

The new laminate that was designed had a cheaper and more durable one-layer structure. All the wirings were placed on one side of the laminate with a continuous pattern: the green dashed lines show the lines where the element can be cut. The number of wires was reduced in two ways. Only every other NFI element (red squares) was surrounded by an RFID antenna, and the antenna and the element had a common signal wire (blue line) (Fig. 20) [2]. Hence only three wires are needed to feed two elements and one antenna [P3].

<sup>10</sup> Published in *Wireless Personal Communications*, vol. 59, no. 1, p. 62.

### 3.2 New MUX unit

The MUX unit was designed to operate with the new laminate. The RFID signal was increased to get stronger fields to ensure better reliability of the operation. A new switching technique was used so that the ELSI and RFID systems could use the common wires (Fig. 20, Fig. 21). Switch S1 selects whether the NFI or RFID signal is transmitted. If the NFI signal is transmitted, switch S2 is turned to the high-impedance state and the signal flows to the capacitive sensor plate. When the RFID signal is fed to the loop antenna, switch S2 connects the return path. (Fig. 21) [P3, 2].

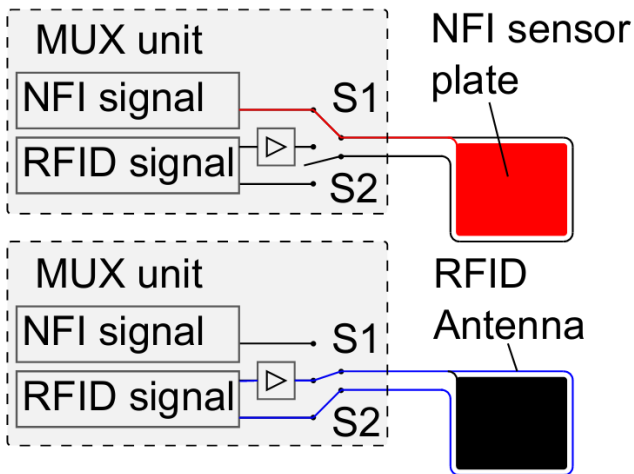

**Fig. 21** NFI and RFID use the same signal wires. The MUX unit switches either signal on.

The MUX unit (Fig. 21) does the switching and amplifying using metal-oxide-semiconductor (MOS) transistors (Fig. 22). The PMOS transistors can be turned to the OFF state by setting the RFID signal to +5V. Consequently, the NMOS is also set to the OFF state. The NFI signal is then fed to the sensor plate because the antenna return path is in the high-impedance state (Fig. 22). When the RFID signal is transmitted, the NFI source is set to the high-impedance state. The RFID signal is transmitted simply by creating ASK modulation by turning the PMOS transistors to the ON and OFF states [P3].

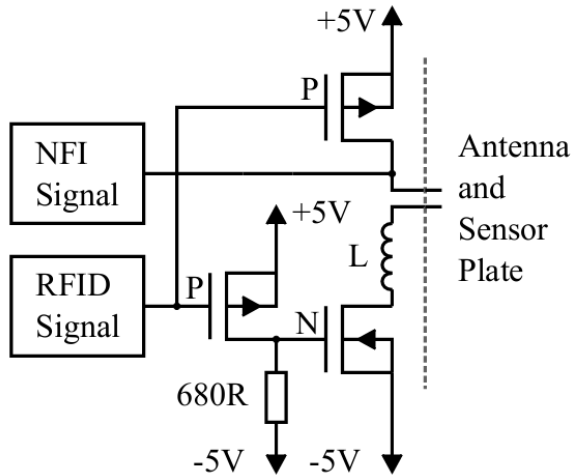

Fig. 22 Switching and current amplifier circuit. <sup>11</sup>

The current in the antenna loop is limited with an inductor  $L$ . Because the wire length in the laminate varies according to the location of the antenna, so does the resistance, from  $3\ \Omega$  to  $30\ \Omega$ . Hence the inductor values were selected to achieve the same targeted  $100\text{-mA}_{\text{RMS}}$  current in every antenna [P3].

### 3.3 The tag that was designed

RFID tags were created to demonstrate the localization and identification capabilities of the system. Two different tags were developed to implement the LF localization system. The first prototype was built to verify the concept of LF transmission with the antenna loops on the floor. The tag consisted of an MAS9180 LF receiver (Micro Analog Systems Oy, Finland) [71], ATmega88 microcontroller (Atmel Corporation, CA, USA) [72], and CC2500 transceiver (Texas Instruments Inc., TX, USA) [73] [P1].

The first prototype was very sensitive in the LF channel. A read height of over 2.5 m could be achieved even though the receiving antenna was not optimal. However, the MAS9180 receiver allowed only an extremely low data rate of 16 bps, which was not sufficient. It was then decided to use AS3931 (Austria Microsystems AG, Austria) as the LF receiver because of its superior data transmission rate compared to the MAS9180 [71,74] [P1].

In the first prototype the CC2500 transceiver was used as the high-frequency (HF) radio [75]. The chip worked well. However, it was decided to use a more scalable protocol in order to be able to build an institution-size network. The protocol should implement wide peer-to-peer networks and low power consumption in order for it to be possible to use it for days

<sup>11</sup> Published in *Wireless Personal Communications*, vol. 59, no. 1, p. 64.

without charging the batteries. ZigBee was selected as the HF medium because of its ability to build up large mesh networks [76,77] and beaconing ability to scale down the power consumption [78][P2].

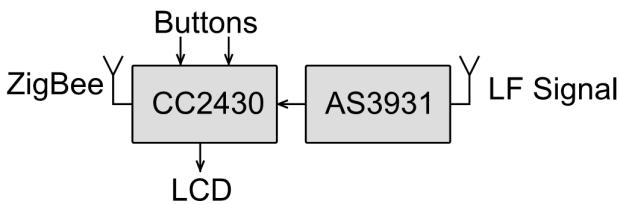

Fig. 23 The tag that was designed and its functional blocks <sup>12</sup>

The tag consisted of an LF receiver, microcontroller, ZigBee radio, two buttons, and a display (Fig. 23). The receiver was used to detect, amplify, and correlate the LF signal. AS3931 was selected as the receiver because of its good compromise between data rate and sensitivity [79]. The data in a ZigBee network can be encrypted and thus it can be used to transmit sensitive information [80]. CC2430-SoC (system on chip) was selected as the controller unit, because the chip also includes a ZigBee radio [81]. The single-chip solution saved space on the circuit board. The microcontroller decodes the received LF signal, adds the ID number, and sends the data back to the system using the ZigBee network [P2].

### 3.4 The pilot system that was built

A pilot installation in a laboratory room was built to test and measure the performance of the RFID system. The room was located in the Department of Electronics of Aalto University, Espoo, Finland. The room was 6.4 m long and 4.6 m wide. The sensors were placed on 22-mm chipboard panels and

---

<sup>12</sup> Published in the International Journal on Smart Sensing and Intelligent Systems, vol. 4, no. 1, p. 82.



the system consisted of a 9 x 15 ELSI sensor matrix and a 9 x 8 antenna matrix. The sensors were then covered with 3-mm PVC flooring. The pilot included both the ELSI and the RFID systems.

The pilot system is controlled with a main unit. The unit uses a controller area network (CAN) bus to communicate with a measurement unit (MU). The MU is responsible for feeding the signals to the right NFI sensor plates via a multiplexer and measuring the possible changes [28]. It also creates the carrier frequency and the modulation for the RFID (LF) transmissions and routes them to the correct loops. The MU sends the NFI localization information back to the main unit via the CAN bus. If the RFID tags receive the LF signals, the localization and identification information is sent back to the main unit via a high-frequency (HF) network (Fig. 24) [P1-P4]. The main unit then locates the people, using the NCL localization as described previously in Sections 2.2 and 2.3 [P4].

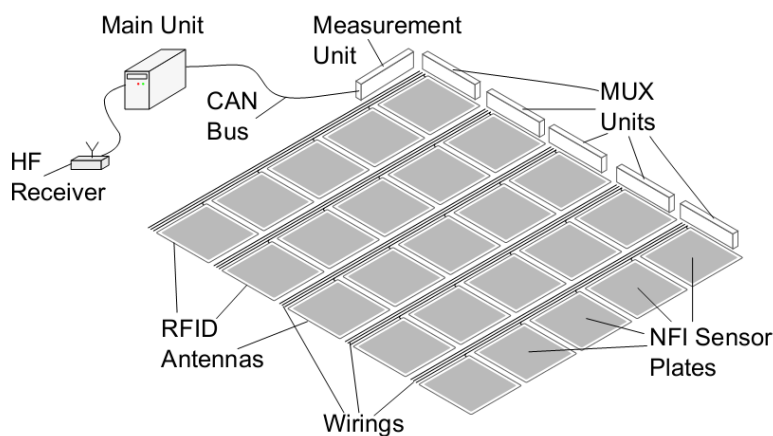

**Fig. 24** The pilot system that was built

The pilot system also had two active areas (AA) that could be used to test the context-based services. These areas were used to demonstrate the functions of the multifunctional name tag. For the proof of the concept, the existing hardware was used [P5]. The localization and the identification were performed with the RFID tag [P2, P3, P4]. Because it would have been quite a big task to build a tag with a touch screen and wireless capability, an iPod Touch® (Apple Inc. California, USA) [82] was used as a multifunctional name label [P5].

In the demonstration, the main unit also acts as a web server, which changes the web page on the iPod depending on the location (cell) of the user. If the identified cell moves to an AA, the main unit changes the pages on the iPod's browser. Every browser opens the page with the same

identifier as in the RFID tag, for example “index.html?Ropponen” so that the system knows to change only the page of that iPod when necessary [P5].

## 4. Results

### 4.1 Magnetic field of the LF transmitter

The LF transmission system was measured to meet the European Radiocommunications Committee (ERC) recommendation ERC/REC 70-03 for inductive applications, which stipulates that the magnetic field should stay below 42 dB $\mu$ A/m at a range of 10 meters (70-119-kHz frequency band) [83]. When the signal was transmitted with a 100-mA current, the electric field was 47 dB $\mu$ V/m at best at a distance of 2.7 meters [P1]. Using Equations 1 and 2, the calculated magnetic field is 41 dB $\mu$ A/m. Hence, at the distance of 10 meters, the magnetic field is well below the allowed maximum signal strength.

### 4.2 Read range and signal penetration

New MUX units, new laminates, and the RFID tag were used to measure the coverage volume of an antenna. A 100-mA<sub>RMS</sub> LF signal was fed to the loop and the detection distance from the antenna center was taken down in five different directions (+X, +Y, -X, diagonal +X+Y, and diagonal -X+Y). Fig. 25 shows the detection height in relation to the distance from the antenna center (a) and all the measured values in a 3D plot (b).

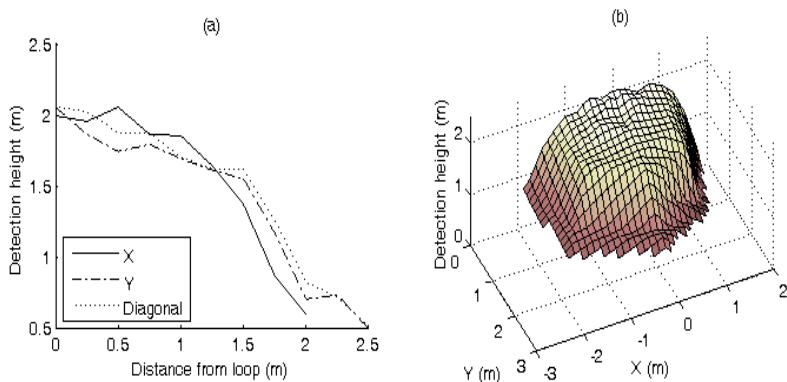

**Fig. 25** Detection volume on one antenna loop. The antenna center is at the origin.<sup>13</sup>

It was also shown that the read height remains at the same height of 2 meters even if the tag is placed inside normal objects, for example in a briefcase or a wallet or even in an antistatic bag. The human body did not affect the read range in the tests. [P3].

The height was lower in the cases where a ferromagnetic object, for example 11 $\mu$ m thick aluminum foil, was placed near to the receiving antenna. With 125 kHz carrier frequency, the attenuation was calculated using equations 3 and 4 and it was 0.4 dB (bulk conductivity  $\sigma$  for aluminium is  $37.8 \times 10^6$  S/m). This low attenuation did not explain the lower read height, so it was shown that the circulating currents caused by the foil affected the antenna's tuning. [P3].

If the system was installed on the second floor in a building it could have been possible for the LF signal to be received unintentionally on the floor below. That is because theoretically, a loop antenna creates a similar field on both sides of the antenna plane in free space [66]. When a 100-mA<sub>RMS</sub> current was transmitted to an antenna and the magnetic field was measured on the floor below, the signal was attenuated by a normal 265-mm-thick reinforced concrete cavity slab below the noise level [P2].

<sup>13</sup> Published in *Wireless Personal Communications*, vol. 59, no. 1, p. 66.

### 4.3 Identification speed

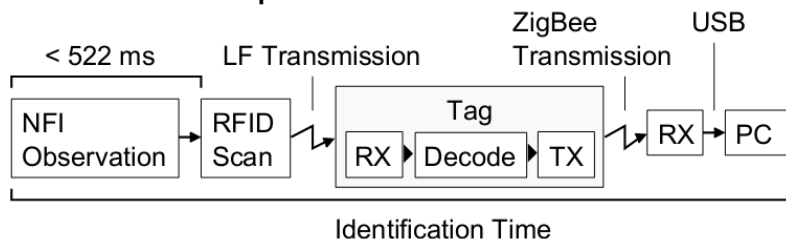

Fig. 26 Identification cycle<sup>14</sup>

It was necessary to know how long it takes for the system to acknowledge with identification when a person arrives in a room. The incoming person was located and identified with NCL. The identification cycle time from the beginning of the RFID scan to the receiving of the identification with the PC was calculated from timestamp values. The NFI scan is running constantly and it takes up to 522 ms in the test room to observe a person. Hence a random value between 0 and 522 ms was added to the time stamp so that the speed would indicate the real identification speed (Fig. 26) [P4]. The test room was entered 100 times. The RFID identification cycle took 281 ms  $\pm$  5 ms (S. D.). When the random value (0-522 ms) was added, the average identification latency was 540 ms  $\pm$  158 ms (S. D.).

---

<sup>14</sup> Published in the International Journal on Communications Antenna and Propagation (IRECAP), Vol. 1 No. 2, 2011. Quoted with the permission of the publisher, Praise Worthy Prize S. r. l. <http://www.praiseworthyprize.com/>; [info@praiseworthyprize.com](mailto:info@praiseworthyprize.com), p. 154.

#### 4.4 Localization accuracy of the RFID system

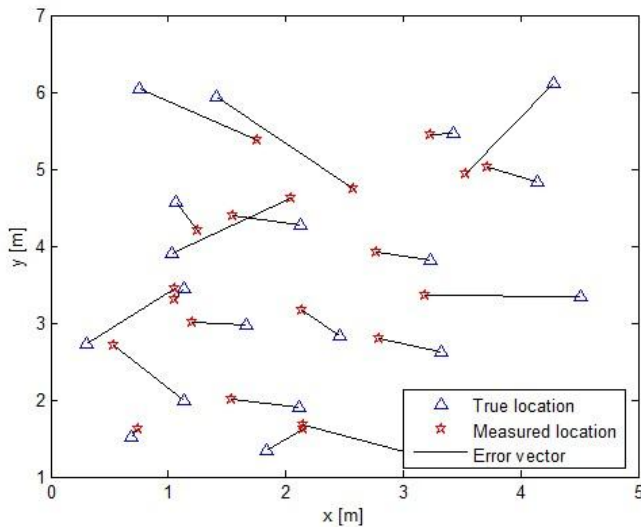

Fig. 27 Localization accuracy of NCL <sup>15</sup>

The performance of NCL was tested in the pilot room. The tag was held in a hand, 1 meter above the floor surface, and the NCL scan was run at 20 fixed spots (Fig. 27). The calculated tracking error of the RFID system was [0.50 m, 0.32 m] on the x- and y-axes, respectively, with a standard deviation of  $\pm$  [0.29 m, 0.27 m]. The tracking error of the whole system was 0.64 m  $\pm$  0.31 m (S. D.) [P4].

#### 4.5 Discrimination performance

Two persons with a tag were in the test room, which was divided with a line to measure the discrimination performance of the system. The pilot room was halved with a line and the two persons wandered around only on their own sides in order for it to be known which NFI cell belonged to which person. The RFID localization (with the identification) was then compared with the NFI results. The test was passed if both person 1's and person 2's NFI and RFID estimates were closest to each other. In 72% of the cases person 1's identifications were correct and in 86% of them person 2's were. In 60% of the cases, both identifications were right. Fig. 28 shows how the

---

<sup>15</sup> Published in the International Journal on Communications Antenna and Propagation (IRECAP), Vol. 1 No. 2, 2011. Quoted with the permission of the publisher, Praise Worthy Prize S. r. l. <http://www.praiseworthyprize.com/>; [info@praiseworthyprize.com](mailto:info@praiseworthyprize.com), p. 155.

discrimination performance relates to the distance between the persons [P4].

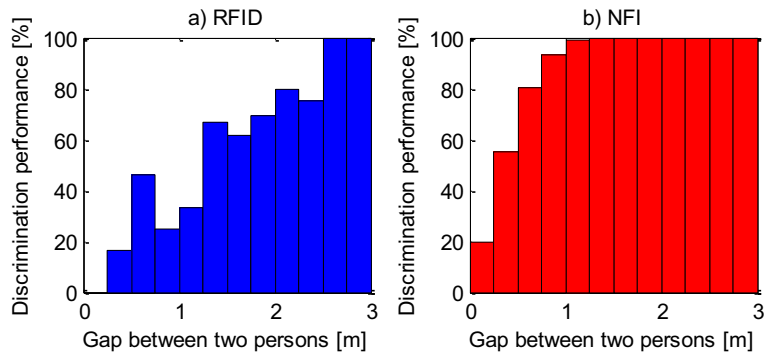

Fig. 28 Discrimination performance of the RFID and ELSI systems<sup>16</sup>

From the same values the percentage was calculated of in how many cases the identification would have been right if the combining was done just by connecting the first identification to the nearest cell and with the use of NNDA (random start, NNDA, Section 2.3). With a random start, the identification was correct in 79% of the cases. Using the NNDA, the discrimination performance improved to 89% and the discrimination was correct every time when the two people were over 2 meters away from each other [P4].

---

<sup>16</sup> Published in the International Journal on Communications Antenna and Propagation (IRECAP), Vol. 1 No. 2, 2011. Quoted with the permission of the publisher, Praise Worthy Prize S. r. l. <http://www.praiseworthyprize.com/>; [info@praiseworthyprize.com](mailto:info@praiseworthyprize.com), p. 155

#### 4.6 Demonstration of the name tag concept

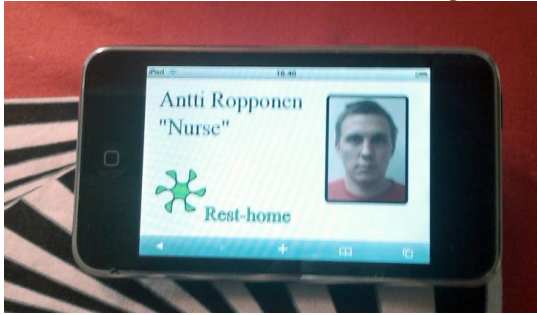

Fig. 29 The tag acts as a name label<sup>17</sup>

The multifunctional name tag concept was piloted in the test room using the iPod Touch and the identification tag. When the person entered the test room, the RFID tag was recognized and the NFI location cell got the identification. The iPod's identifier was then linked to the corresponding cell. In the initial phase, a name label appeared on the screen (Fig. 29). When the person went on an AA, the system then changed the user interface on the iPod, depending on the context. For example, when the person went near a bed (Fig. 2), the patient records appeared on the screen (Fig. 30) and near the door (Fig. 2), the user interface showed the door's security buttons (Fig. 30) [P5]. When the user left the AA's, the iPod changed back to the name tag.

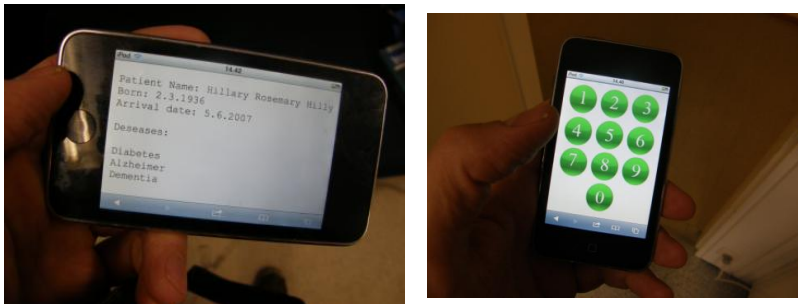

Fig. 30 The multifunctional tag acts as a display of patient records and door buttons<sup>18</sup>

---

<sup>17</sup> Published in Personal and Ubiquitous Computing, Online First™, 19 November 2011

<sup>18</sup> Published in Personal and Ubiquitous Computing, Online First™, 19 November 2011



## 5. Discussion

It was demonstrated that the RFID system may be embedded into the ELSI system. To enable the RFID functionality to be used, the ZigBee network and the tags have to be added to the system on the hardware level. Additionally, the ELSI software must be upgraded with NCL scanning and NNDA algorithms. Dual-band RFID has been demonstrated to be a workable method for tracking and identifying people, along with the ELSI system [P1]-[P4]. It also offers a versatile platform for context-based solutions [P5].

### 5.1 Localization accuracy

The measured localization accuracy of the RFID system was  $0.64 \text{ m} \pm 0.31 \text{ m}$  (S. D.). The result is comparable to other active localization methods. If the RFID system is combined with the ELSI system, the localization accuracy gets even better [P4]. Table 2 shows that the more accurate active systems that are listed need an additional dense sensor infrastructure. WLAN with fingerprints requires the burdensome installation part to collect the initial localization information [84, 86].

**Table 2** Different localization techniques in comparison

<b>Technology</b>	<b>Author</b>	<b>Accuracy (m)</b>	<b>Major Additional Infrastructure</b>
LF RFID	Ropponen [P4]	1.0	No
LF RFID with ELSI	Ropponen [P4]	0.3	No
ZigBee	Cho [36]	1.8	No
WLAN	Youssef [85]	1.6	No
WLAN+Fingerprint	Sertthin [86]	0.8	No
Visible light	Cheok [38]	1.2	Yes
Ultrasound	Priyantha [40]	0.1	Yes
UHF RFID	Hähnel [87]	2 m	Yes

The LF RFID antenna matrix and the transmitting electronics are embedded to the ELSI system so it does not demand additional installation. Hence, the LF system is the best choice to be used if the extra infrastructure that is needed and localization accuracy are taken into account together. If the ELSI system was not used, it would be more convenient to use most of the other active localization systems. However, in new buildings and during renovations, there might be sense in installing the laminate into the floor to have the ELSI and RFID capability.

## 5.2 Read range and penetration

A sufficient read height of two meters was achieved to build a robust identification system. It was also shown that normal objects do not affect the LF signal. However, circulating currents caused by large metallic objects greatly reduce the sensitivity of the reception. Hence, problems might come up, for example, if the tag is attached to a steel equipment trolley. Strong magnetic fields, for example in an industrial or medical environment, might also affect the signal or even cause false receptions.

## 5.3 Combining the RFID and ELSI information

Combining the localization information of the ELSI and RFID systems should still be improved. It may not be adequate for some applications that the identification of the cells is robust only when the tagged people or objects are more than two meters away from each other. However, very often one person is already in the room and has already been identified. In that case, the identification of the incoming person can be attached to the new unidentified cell immediately.

If two persons are very close to each other, the ELSI system cannot distinguish between them and their location cells are combined. That is not

a problem, because if they were at a distance of one meter, they would probably be in the same AA and thus using the same context-based services. The cell would then have just two identifications. However, a problem arises when the two people separate. Then the system again has to identify two cells that are at a distance of less than two meters.

The discrimination performance could be improved with a different kind of RFID localization algorithm. The LF signal would then be transmitted to the antennas that are near to one NFI cell, but at the same time at the greatest available distance from each other. Hence there would be an attempt to find an antenna whose range includes only one tag. In the case of Fig. 16, antenna number 7 would be used to identify cell A and number 12 to identify B, because those are near to the corresponding cells but far away from each other.

Another option to improve the discrimination performance could be to use multiple levels of LF transmission power. When low power is transmitted, the coverage volume is small. Hence smaller areas can be outlined with one antenna, which enhances the localization and thus discrimination performance. Reducing the transmission power also reduces the reading height. However, it is rare for the tag to be held at a height of 2 meters, which is the maximum detection range. That height is needed to make the system robust but in many cases, less than maximum transmission power is needed.

#### **5.4 Multifunctional user interface and RFID tag**

Even though the multifunctional name label remained a demo version with the iPod Touch, the pilot gave valuable information. It was shown that the ELSI and the RFID systems can be used as a localization platform and that the browser-based system works. Development of the user interface with web tools is easy or at least well known and gives practically unlimited possibilities for the services. Additionally, there are numbers of platforms that can be used to build the communication system between a browser and a database. However, modern browsers demand more from the operating systems and therefore also from the hardware. For example, Meego [88], Android [89], and Ångström[89] are tailored to be used with a touch screen and a mobile environment, but they demand powerful ARM processors.

The next step is to build a multifunctional tag that has a touch screen and the other required hardware, so that the tag can be located with the LF RFID infrastructure. The tag would include at least the functional blocks shown in Fig. 31. The display would at first be a conventional LCD display, because EPDs are not yet at such a level that those could be used [P5].

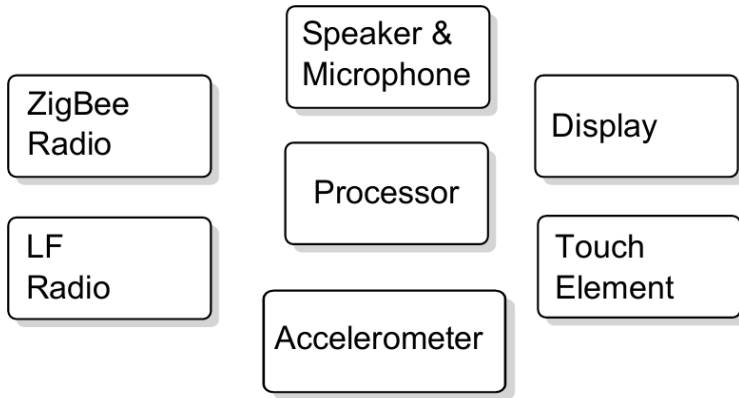
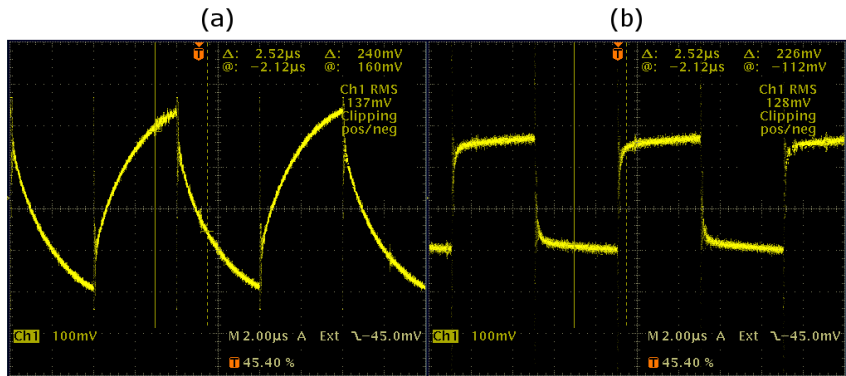

**Fig. 31** Functional blocks of a multifunctional tag

### 5.5 Improvements to the design

Even though the laminate that was tested provided a good compromise between NFI sensitivity and RFID localization performance, the basic construction still had some flaws. The crimp connection between the electronics and the aluminum laminate was prone to failure. A possible reason is that the connection is not hermetic. The aluminum creates some insulating oxide. Hence many antennas broke down during the tests [P3].

The MUX unit had a slight flaw in its design. The compensation inductor that was used affected the waveforms of the antenna (Fig. 32). In the first antenna, which had the largest compensation inductor, the waveform was reminiscent of a triangular wave, while in the eighth, the waveform was more like a square wave. Even though the rms currents were approximately the same in both antennas, different waveforms created unequal magnetic fields [90]. This could be improved by using a constant current source.



**Fig. 32** Current in the first (a) and the eighth antenna (b)<sup>19</sup>

The transmitting antennas cannot be tuned with a capacitor. The inductance of an antenna loop is  $3.7 \mu\text{H}$  [P3] and thus the tuning capacitor in the 125-kHz carrier frequency should be  $0.4 \mu\text{F}$ . Because the DC resistance of an antenna with the wirings can be up to  $30 \Omega$  [P3], the RC time constant is at most  $13 \mu\text{s}$ . From Fig. 32 it can be seen that the modulation cycle takes  $8 \mu\text{s}$ . Hence the tuning capacitor would spoil the modulation. However, a better gain and thus a better read range might be achieved if, for example, two antennas were transmitting at the same time with fixed phase [91].

<sup>19</sup> Published in *Wireless Personal Communications*, vol. 59, no. 1, p. 67.

## 6. Conclusions

An active localization and identification system that can be used with the existing ELSI system was developed. The main targets 1-4 were fulfilled, as can be seen below.

**1) To create a localization and identification system which can cooperate with the existing ELSI system**

A method to locate and identify people using almost only the existing ELSI infrastructure was developed. Active RFID tags, slight modifications to the MUX units and ELSI software, a ZigBee network, and related software are required to include identification capability in the system. A new layout for the ELSI laminate was suggested. The laminate includes both the NFI elements and the RFID antennas on a single layer. The one-layer structure is more durable and cheaper to manufacture than the previous two-layer laminate

**2) To create a system where passive location information is used to improve the localization accuracy of an active localization system**

A nearest cell localization algorithm was created to improve the localization accuracy of the RFID system. The ELSI system selects the antennas that are used for the RFID localization. This improves the RFID tracking error but also the speed of an RFID scan.

**3) To create a platform for various kinds of applications and context-based services**

The ELSI system with the RFID system that was developed offers a platform to create various kinds of context-based services. The ZigBee network enables the system to be expandable. The medium may be used to transmit normal localization and identification data,

but also alarms and context-related information. However, a multifunctional tag that can communicate with the system should be devised. The tests with the iPod Touch gave valuable information on how the interaction mechanism between the tag and the main system should be web-based.

**4) To demonstrate the operation of the localization system that was created in the laboratory environment**

With the demonstration installation, the LF signal may be received 2 meters above the floor. The signals that are transmitted do not violate ERC recommendations. LF signals cannot be received unintentionally on the floor below if there is a typical reinforced concrete cavity slab between the floors. The localization accuracy of the system when NCL is used is  $0.64 \text{ m} \pm 0.31 \text{ m}$  (S. D.), which is more than most active methods are capable of.. This method combined identification and localization data robustly. When an RFID identification is added to the NFI cell, the tracking error is below 30 cm.

# References

- [1] A. Ropponen, *Henkilön paikantamiseen ja tunnistamiseen soveltuva radiojärjestelmä*, Master's thesis, Department of Electrical and Communications Engineering, Helsinki University of Technology, 2007. (in Finnish)
- [2] A. Ropponen, K. Kronström, & O. Auterinen, Planar Sensor Structure, WO2009130373 (A1), 2009.
- [3] A. Ropponen, Interface to a Planar Sensor System and the Control of Same, WO2010109061 (A1), 2010.
- [4] J. E. Cohen, "Human Population: The Next Half Century", *Science* 302 (5648), pp. 1172-1175, 2003.
- [5] Bloom, D., Canning, D., "Global Demographic Change: Dimensions and Economic Significance", *NBER Working Paper*, vol. 10817, 2004.
- [6] H. Rimminen, *Detection of human movement by near field imaging: development of a novel method and applications*, Doctoral dissertation, Aalto University, School of Science and Technology, Faculty of Electronics, Communications and Automation, Department of Electronics, 2011.
- [7] R. Oksanen, S. Paldanius, J. Nykänen, M. Linnavuo, K. Raivio, K. E. Segerstam, R. Sepponen, L. Pohjola, H. Finne-Soveri, "Testing and adopting floor-sensor solutions in daily practice for patient safety in the Kustaankartano nursing home", *J. Nutr. Health. Aging*, vol. 13, supplement 1, p. 361, Jul. 2009 [abstract] and at 19th IAGG World Congress of Gerontology and Geriatrics, Paris, France, 2009 [poster].
- [8] M. Alwan, D. C. Mack, S. Dalal, S. Kell, B. Turner, R. A. Felder, "Impact of passive inhome health status monitoring technology in home health: Outcome pilot," in *Proc. 1<sup>st</sup> Transdisciplinary Conference on Distributed Diagnosis and Home Healthcare*, Arlington, VA, US, pp. 79-82, 2006.
- [9] M. Linnavuo, H. Rimminen, "Localization and Monitoring of People With a Near-Field Imaging System: Boosting the Elderly Care", chapter in *Pervasive and Smart Technologies for Healthcare: Ubiquitous Methodologies and Tools*, A. Coronato and G. De Pietro, Eds. Hershey, PA: IGI Global, pp. 78-96, 2010.
- [10] H. Rimminen, M. Linnavuo, R. Sepponen, "Human Identification and Localization Using Active Capacitive RFID Tags and an Electric Field Floor



- Sensor”, *International Review of Electrical Engineering*, Vol. 5, No. 3, pp. 1061-1068, 2010.
- [11] G. Biffi Gentili, F. Dori, E. Iadanza, “Dual-frequency active RFID solution for tracking patients in a children's hospital. Design method, test procedure, risk analysis, and technical solution”, *Proceedings of the IEEE* 98 (9), pp. 1656-1662, 2010.
  - [12] S.-W Wang, W.-H. Chen, C.-S. Ong, L. Liu, Y.-W. Chuang, “RFID applications in hospitals: a case study on a demonstration RFID project in a Taiwan hospital”, *Proceedings of the Annual Hawaii International Conference on System Sciences* 8, p. 184a, 2006.
  - [13] G. D. Abowd, C. G. Atkeson, J. Hong, S. Long, R. Kooper, M. Pinkerton, “Cyberguide: A mobile context-aware tour guide”, *Wireless Networks* 3 (5), pp. 421-433, 1997.
  - [14] S. Thrun, M. Bennewitz, W. Burgard, A. B. Cremers, F. Dellaert, D. Fox, D. Hähnel, C. Rosenberg, N. Roy, J. Schulte, D. Schulz, “MINERVA: A Second-Generation Museum Tour-Guide Robot”, *Proceedings - IEEE International Conference on Robotics and Automation* 3, pp. 1999-2005, 1999.
  - [15] M. B. Skov, R. T. Høegh, “Supporting information access in a hospital ward by a context-aware mobile electronic patient record”, *Personal and Ubiquitous Computing* 10 (4), pp. 205-214, 2006.
  - [16] E. Ammenwerth, A. Buchauer, B. Bludau, R. Haux, “Mobile information and communication tools in the hospital”, *International Journal of Medical Informatics*, Volume 57, Issue 1, pp. 21-40, 2000.
  - [17] M. Ancona, G. Dodero, F. Minuto, M. Guida, V. Gianuzzi, “Mobile computing in a hospital: the WARD-IN-HAND project”, *Proceedings of the 2000 ACM Symposium on Applied Computing - Volume 2*, pp. 554-556.
  - [18] S. Bryan, G. C. Weatherburn, J. R. Watkins, M. J. Buxton, “The benefits of hospital-wide picture archiving and communication systems: a survey of clinical users of radiology services”, *The British Journal of Radiology*, Vol 72, Issue 857 469-478, 1999.
  - [19] E. Kaasinen, “User needs for location-aware mobile services”, *Personal and Ubiquitous Computing*, Vol. 7. No. 1, 2003.
  - [20] D. Salber, A. K. Dey, G. D. Abowd, “Context toolkit: Aiding the development of context-enabled applications”, *Conference on Human Factors in Computing Systems - Proceedings*, pp. 434-441, 1999.
  - [21] J. Krumm, S. Harris, B. Meyers, B. Brumitt, M. Hale, S. Shafer, “Multi-Camera Multi-Person Tracking for EasyLiving”, *Proceedings of the Third IEEE International Workshop on Visual Surveillance (VS'2000)*, 2000.
  - [22] M. Harville, “Stereo person tracking with adaptive plan-view templates of height and occupancy statistics”, *Image. Vision. Comput.*, vol. 22, no. 2, pp. 127-142, Feb. 2004.

- [23] M. D. Addlesee, A. Jones, F. Livesey, F. Samaria. "The ORL Active Floor", *IEEE Personal Communications*, 5(4), pp. 35-41, 1997.
- [24] R. J. Orr, G. D. Abowd, "The Smart Floor: A Mechanism for Natural User Identification and Tracking", *Conference on Human Factors in Computing Systems (CHI 2000)*, The Hague, Netherlands, April 1-6, 2000.
- [25] J. Lekkala, M. Paaanen, "EMFi – New electret material for sensors and actuators", *Proceedings of the IEEE. 10th International Symposium on Electrets*, pp. 743-746, 1999.
- [26] T. G. Zimmerman, "Personal area networks: near-field intrabody communication", *IBM Systems Journal*, Vol. 35, Nos. 3 & 4, pp. 609-617, 1996.
- [27] D. Savio, T. Ludwig, "Smart carpet: a footstep tracking interface", in Proc. *21st Int. Conf. on Advanced Information Networking and Applications Workshops*, AINAW '07, Niagara Falls, Canada, pp. 754-760, 2007.
- [28] H. Rimminen, M. Linnavuo, R. Sepponen, "Human Tracking Using Near Field Imaging", in Proc. *2nd International Conference on Pervasive Computing Technologies for Healthcare*, Tampere, Finland, Jan. 30.-Feb. 1, pp. 148-151, 2008.
- [29] M. Valtonen, J. Mäentausta, J. Vanhala, "Tiletrack: Capacitive human tracking using floor tiles", *7th Annual IEEE International Conference on Pervasive Computing and Communications*, Galveston, TX, 9-13 March, 2009.
- [30] H. Rimminen, J. Lindström, R. Sepponen. "Positioning accuracy and multi-target separation with a human tracking system using near field imaging", *Int. J. on Smart Sensing and Intelligent Systems*. 2(1), pp. 156-175, 2009.
- [31] M. Williams, "Better Face-Recognition Software", *Technology Review*, 30 May, 2007.
- [32] S. Zheng, H. Qiao, B. Zhang,, P. Zhang, "The application of intrinsic variable preserving manifold learning method to tracking multiple people with occlusion reasoning", *2009 IEEE/RSJ International Conference on Intelligent Robots and Systems, IROS 2009*, pp. 2993-2998, 2009.
- [33] C. BenAbdelkader, R. Cutler, L. Davis, "Stride and cadence as a biometric in automatic person identification and verification", in Proc. *Fifth IEEE International Conference on Automatic Face and Gesture Recognition, Washington, D.C.*, pp. 372-377, May 21, 2002.
- [34] H. Rimminen, J. Lindström, R. Sepponen, "Positioning Accuracy And Multi-Target Separation With A Human Tracking System Using Near Field Imaging", *International Journal on Smart Sensing and Intelligent Systems*, Vol. 2, No. 1, March 2009.

- [35] P. Hii, A. Zaslavsky, "Improving location accuracy by combining WLAN positioning and sensor technology", *Workshop on Real-World Wireless Sensor Networks (REALWSN'0)*, Stockholm, Sweden, June 20-21, 2005.
- [36] H. Cho, M. Kang, J. Park, B. Park, H. Kim, "Performance analysis of location estimation Algorithm in ZigBee Networks using Received Signal Strength", in *Proc. 21st International Conference on Advanced Information Networking and Applications Workshops (AINAW'07)*, Niagara Falls, Canada, May 21-23, pp. 302-306, 2007.
- [37] *Ekahau RTSL Controller datasheet*, Ekahau Inc., Helsinki, Finland, 2010.
- [38] A. D. Cheok, Y. Li, "Ubiquitous interaction with positioning and navigation using a novel light sensor-based information transmission system", *Personal and Ubiquitous Computing* 12 (6), pp. 445-458, 2008.
- [39] R. Want, A. Hopper, V. Falcao, J. Gibbons, "The active badge location system", *ACM Transaction on Information Systems*, vol. 10, issue 1, pp. 91-102. 1992.
- [40] N. B. Priyantha, *The Cricket Indoor Location System*, Doctoral thesis, Massachusetts Institute of Technology, Department of Electrical Engineering and Computer Science, June 2005.
- [41] M. Hazas, A. Ward, *A Novel Broadband Ultrasonic Location System, Lecture Notes in Computer Science*, Springer Berlin/Heidelberg, Vol. 2498/2002, January 2002
- [42] T. Hori, Y. Nishida, H. Aizawa, S. Murakami, H. Mizoguchi, "Sensor network for supporting elderly care home", *Proceedings of IEEE Sensors 2*, pp. 575-578, 2004.
- [43] A. Harter, A. Hopper, P. Steggles, A. Ward, P. Webster, "The Anatomy of a Context-Aware Application", *Wireless Networks*, vol.2, No. 2, pp. 187-197, 2002.
- [44] Active Bat website, <http://www.cl.cam.ac.uk/research/dtg/attarchive/bat/>, 2010.
- [45] J. Hightower, G. Borriello, "Location systems for ubiquitous computing", *Computer*, vol. 34, no. 8, pp. 57-66, Aug 2001.
- [46] Y. Gu, A. Lo, I. Niemegeers, "A survey of indoor positioning systems for wireless personal networks", *IEEE Communications Surveys and Tutorials*, vol. 11, no. 1, pp. 13-32, 2009.
- [47] E. Blomme, D. Bulcaen, F. Declercq, P. Lust, "Air-coupled ultrasonic evaluation of coated textiles", in *Proc. 2002 IEEE Ultrasonics Symposium*, vol.1, pp. 757-760, 8-11 Oct. 2002.
- [48] M. Brunato, K. Csaba, "Transparent location fingerprinting for wireless services", *Proc. Med-Hoc-Net*, 2002.
- [49] K. Kaemarungsi, P. Krishnamurthy, "Modeling of Indoor Positioning Systems Based on Location Fingerprinting", *Proceedings - IEEE INFOCOM 2*, pp. 1012-1022, 2004.

- [50] Y.-C. Chen, J.-R. Chiang, H.-H. Chu, P. Huang, A. W. Tsui, "Sensor Assisted Wi-Fi Indoor Location System for Adapting to Environment Dynamics", *International Workshop on Modeling Analysis and Simulation of Wireless and Mobile Systems*, October 10-13, Montreal, Canada. pp. 118-125, 2005.
- [51] V. Honkavirta, T. Perälä, S. Ali-Löytty, R. Piché, "A comparative survey of WLAN location fingerprinting methods", *Proceedings - 6th Workshop on Positioning, Navigation and Communication, WPNC*, pp. 243-251, 2009.
- [52] N. Patwari, A. O. Hero III, "Using Proximity and Quantized RSS for Sensor Localization in Wireless Networks", *Proceedings of the Second ACM International Workshop on Wireless Sensor networks and Applications*, pp. 20-29, 2003.
- [53] L. M. Ni, Y. Liu, Y. C. Lau, A. P. Patil, "LANDMARC: Indoor location sensing using active RFID", *Wireless Networks* 10 (6), pp. 701-710, 2004.
- [54] J. Krumm, K. Hinckley, "The NearMe Wireless Proximity Server", *Lecture Notes in Computer Science (including subseries Lecture Notes in Artificial Intelligence and Lecture Notes in Bioinformatics)* 3205, pp. 283-300, 2004.
- [55] P. A. Jumaa, "Hand hygiene: Simple and complex", *International Journal of Infectious Diseases* 9 (1), pp. 3-14, 2005.
- [56] S. Inoue, H. Kawai, S. Kanbe, T. Saeki, T. Shimoda, "High-Resolution Microencapsulated Electrophoretic Display (EPD) Driven by Poly-Si TFTs with Four-Level Gray Scale", *IEEE Transactions on Electron. Devices*, Vol. 49, No. 8, Aug. 2002.
- [57] Y. Chen, J. Au, P. Kazlas, A. Ritenour, H. Gates, M. McCreary, "Flexible Active-Matrix Electronic Ink Display", *Nature* 423 (6936), pp. 136, 2003.
- [58] Y. Kwak, J. Park, D.-S. Park, J. B. Park, "Generating Vivid Colors on Red-Green-Blue-White Electronic-Paper Display", *Applied Optics*, Vol. 47, Issue 25, pp. 4491-4500, 2008.
- [59] C.-H. Liu, Y.-F. Chung, T.-W. Chiang, T.-S. Chen, S.-D. Wang, "A Mobile Agent Approach for Secure Integrated Medical Information Systems", *Journal of Medical Systems*, pp. 1-11, Article in Press, 2011.
- [60] O. Günther, S. Spiekermann, "RFID and the perception of control: The consumer's view", *Communications of the ACM* 48 (9), pp. 73-76, 2005.
- [61] A. P. Gurses, P. Carayon, "Exploring performance obstacles of intensive care nurses", *Applied Ergonomics* 40 (3), pp. 509-518, 2009.
- [62] M. Ancona, G. Dodero, F. Minuto, M. Guida, V. Gianuzzi, "Mobile computing in a hospital: the WARD-IN-HAND project", in *Proc. of the 2000 ACM Symposium on Applied Computing*, Vol. 2, pp. 554-556, 2000.
- [63] L. Bai, S. Biswas, F. Ferrese, "Design of a reliable distributed secure database system", *Proceedings - 2010 IEEE International Conference on Networking, Architecture and Storage, NAS 2010*, pp. 91-99, 2010.

- [64] S. Neubert, D. Arndt, K. Thurow, R. Stoll, "Mobile real-time data acquisition system for application in preventive medicine", *Telemedicine and e-Health*, 16(4), pp. 504-509, 2010.
- [65] M. D. Rodriguez, J. Favela, E. A. Martinez, M. A. Muñoz, "Location-aware access to hospital information and services", *IEEE Transactions on Information Technology in Biomedicine*, vol. 8, no. 4, pp. 448-455, 2004.
- [66] R. C. Johnson, *Antenna Engineering Handbook*, Third edition, USA, McGraw-Hill Inc., pp. 5-13, 1993.
- [67] C. A. Balanis, *Antenna Theory Analysis and Design*, Second Edition, Toronto, John Wiley & Sons, Inc., pp. 219-224, 1997.
- [68] H. A. Wheeler, "The Radiansphere Around a Small Antenna", *Proceedings of Institute of Radio Engineers*, pp. 1325-1331, 1959.
- [69] J. C. Rautio, V. Demir, "Microstrip conductor loss models for electromagnetic analysis", *IEEE Transactions on Microwave Theory and Techniques*, 51 (3), pp. 915-921, 2003.
- [70] *Analog Devices ADG706/ADG707 datasheet*, Norwood, Maine: Analog Devices Inc., 2002.
- [71] *Micro Analog Systems MAS9180 AM Receiver IC Datasheet*, Finland, Espoo: Micro Analog Systems Oy, 2005.
- [72] *Atmel ATmega88 8-bit Microcontroller datasheet*, USA, California: Atmel Corporation, 2007.
- [73] *Texas Instruments CC2500 Single Chip Low Cost Low Power RF-Transceiver datasheet*, USA: Dallas, Texas Instruments Inc., 2005.
- [74] *Austriamicrosystems AS3931 3D Low Power Wakeup Receiver Datasheet*, Austria, Schloss Premstaetten: Austriamicrosystems AG, 2008.
- [75] *Texas Instruments CC2500 Single Chip Low Cost Low Power RF-Transceiver datasheet*, USA: Dallas, Texas Instruments Inc, 2005.
- [76] F. Ding, G. Song, K. Yin, J. Li, A. Song, "Design and implementation of ZigBee based gateway for environmental monitoring system," *International Conference on Communication Technology Proceedings, ICCT*, Southeast Univ., Nanjing, pp. 93-96, 10-12 Nov. 2008.
- [77] E. Callaway, P. Gorday, L. Hester, J. A. Gutierrez, M. Naeve, B. Heile, V. Bahl, "Home networking with IEEE 802.15.4: A developing standard for low-rate wireless personal area networks", *IEEE Communications Magazine* 40 (8), pp. 70-77, 2002.
- [78] Z. T. Kyaw, C. Sen, "Using the CC2430 and TIMAC for low-power wireless sensor applications: a power-consumption study", *Texas Instruments Analog Applications Journal*, 2Q 2008.
- [79] A. Ropponen, M. Linnavuo, R. Sepponen, "LF Indoor Location and Identification System", *International Journal on Smart Sensing and Intelligent Systems*, vol. 2, no. 1, pp. 94-117, 2009.

- [80] H. Kim, J.-M. Chung, C. H. Kim, "Secured communication protocol for internetworking ZigBee cluster networks", *Computer Communications* 32, (13-14), pp. 1531-1540, 2009.
- [81] *Texas Instruments CC2430 datasheet (rev. 2.1)*, Dallas, Texas: Texas Instruments Inc.
- [82] Apple iPod touch technical specifications. Apple Inc. California, USA. <http://www.apple.com/ipodtouch/specs.html>, Visited 23.12.2008.
- [83] *ERC Recommendation 70-03 Relating to The Use of Short Range Devices (SRD). Version 9*. European Radiocommunications Committee, p. 16, 2007.
- [84] P. Prasithsangaree, P. Krishnamurthy, P. K. Chrysanthis, "On Indoor Position Location with Wireless Lans", Proc. The 13th IEEE International Symposium on Personal, Indoor and Mobile Radio Communications, vol. 2, pp. 720-724, 2002.
- [85] M. A. Youssef, A. Agrawala, "The Horus WLAN Location Determination system", *MobiSys '05: The Third International Conference on Mobile Systems, Applications and Services*. pp. 205-218, 2005.
- [86] C. Serththn, T. Fujii, T. Ohtsuki, M. Nakagawa, "Multi-band received signal strength fingerprinting based indoor location system", *IEICE Transactions on Communications E93-B (8)*, pp. 1993-2003, 2010.
- [87] D. Hähnel, W. Burgard, D. Fox, K. Fishkin, M. Philipose, "Mapping and localization with RFID technology", in *Proc. the IEEE International Conference on Robotics and Automation*, New Orleans, LA, pp. 1015-1020, 2004.
- [88] S. Schroeder, "Introduction to MeeGo", *IEEE Pervasive Computing*, vol. 9, no. 4, 2010.
- [89] K. Paul, T. K. Kundu, "Android on Mobile Devices: An Energy Perspective", *IEEE 10th International Conference on Computer and Information Technology (CIT)*, pp. 2421-2426, 2010.
- [90] R. W. Ramirez, *The FFT, Fundamentals and Concepts*, Prentice-Hall, Inc. A Simon & Schuster Company, Eaglewood Cliffs, New Jersey, USA, 1985.
- [91] H. Morishita, K. Hirasawa, T. Nagao, "Circularly polarised wire antenna with a dual rhombic loop", in *Proc. IEEE Microwaves, Antennas and Propagation*, vol. 145, no. 3, pp. 219-224, June 1998.



An electric sensor with intelligence (ELSI) system was developed to monitor and locate patients, which helps the caring personnel and upgrades the service. The system has been used in many care homes for the elderly in Finland and has proved its benefits for the patients and staff.

The problem with the ELSI system was that it could not identify the people it located.

Additionally, the alarm devices that were used were impractical. Hence a dual-band localization system was introduced to address these deficiencies.

The dual-band system uses active tags that are located with an antenna matrix embedded into the ELSI floor. Combining these two systems an accurate localization and identification infrastructure could be built. The tag communicates with the ELSI system using a ZigBee network, which enables the system to be expandable. The medium may be used to transmit normal localization and identification data, but also alarms and context-related information.



ISBN 978-952-60-4870-3  
ISBN 978-952-60-4871-0 (pdf)  
ISSN-L 1799-4934  
ISSN 1799-4934  
ISSN 1799-4942 (pdf)

**Aalto University**  
**School of Electrical Engineering**  
**Department of Electronics**  
[www.aalto.fi](http://www.aalto.fi)

**BUSINESS +  
ECONOMY**

**ART +  
DESIGN +  
ARCHITECTURE**

**SCIENCE +  
TECHNOLOGY**

**CROSSOVER**

**DOCTORAL  
DISSERTATIONS**